

Ford Manual



Ford Manual





FORD MANUAL

For Owners and Operators
of Ford Cars and Trucks

Copyrighted
by
FORD MOTOR COMPANY
All rights reserved

Published by
Ford Motor Company
Detroit, Michigan, U. S. A.

Foreword

IT is a significant fact that nearly all Ford cars are driven by laymen—by owners, who in the great majority of cases have little or no practical experience with things mechanical.

The simplicity of the Ford car and the easiness with which it is operated renders an intimate knowledge of mechanical technicalities unnecessary for its operation.

And the further fact that there are more than twelve thousand Ford service stations distributed throughout the civilized world—where adjustments and repairs may be had with no annoying delay—gives to Ford owners a singular freedom from mechanical annoyances which beset owners of cars having limited service facilities and distribution.

But while it is not imperative, it is, however, altogether desirable that every Ford owner should thoroughly understand his car. With such knowledge at his command he is always master of the situation—he will maintain his car more economically—prolong its usefulness—and he will also derive more pleasure from it, for it is a truism that the more one knows about a thing the more one enjoys it.

The mastery of a thorough knowledge of Ford construction is by no means a difficult or time-consuming task. The Ford is the simplest car made. It is easy to understand, and is not difficult to keep in proper adjustment and repair.

That the Ford construction may be thoroughly understood—and that there may be an authoritative guide for the making of Ford adjustments—this book is published.

Important

It is most important that owners of Ford cars shall insist upon getting the genuine Ford-made materials, or "parts," when having repairs or replacements made. This will be assured when the car is taken to the authorized Ford agent. Imitation, or "bogus," or counterfeit parts of inferior quality are being made and sold as "Ford Parts." Avoid their use by dealing with the authorized Ford agent.

The Car and Its Operation

What must be done before starting the Car?

Answer No. 1

Before trying to start the car, fill the radiator (by removing cap at top) with clean, fresh water. If perfectly clean water cannot be obtained it is advisable to strain it through muslin or other similar material to prevent foreign matter from getting in and obstructing the small tubes of the radiator. The system will hold approximately three gallons. It is important that the car should not be run under its own power unless the water circulating system has been filled. Pour in the water until you are sure that both radiator and cylinder water jackets are full. The water will run out of the overflow pipe onto the ground when the entire water system has been properly filled. During the first few days that a new car is being driven it is a good plan to examine the radiator frequently and see that it is kept properly filled. The water supply should be replenished as often as may be found necessary. Soft rain water, when it is to be had in a clean state, is superior to hard water, which may contain alkalies and other salts which tend to deposit sediment and clog the radiator. (See chapter on Cooling System.)

What about Gasoline?

Answer No. 2

The ten-gallon gasoline tank should be filled—nearly full—and the supply should never be allowed to get low. Strain the gasoline through chamois skin, to prevent water and other foreign substances from getting into the tank. Dirt or water in the gasoline is sure to cause trouble. When filling the tank be sure that there are no naked flames within several feet, as the vapor is extremely volatile and travels rapidly. Always be careful about lighting matches near where gasoline has been spilled, as the air within a radius of several feet is permeated with the highly explosive vapor. The small vent hole in the gasoline tank cap should not be allowed to get plugged up, as this would prevent proper flow of the gasoline to the carburetor. The gasoline tank may be drained by opening the pet cock in the sediment bulb at the bottom.

How about the Oiling System?

Answer No. 3

Upon receipt of the car see that a supply of medium light, high-grade gas engine oil is poured into the crank case through the breather pipe at the front of the engine (a metal cap covers it). Down under the car in the flywheel casing (the reservoir which holds this oil) you will find two pet cocks. Pour oil in slowly until it runs out of the upper cock. Leave the cock open until it stops running—then close it. After the engine has become thoroughly limbered up, the best results will be obtained by carrying the oil at a level midway between the two cocks—but under no circumstances should it be allowed to get below the lower cock. All other parts of the car are

Steering Wheel, showing reduction gears meshing with the teeth of the gear case and center pinion. (Cut No. 1)

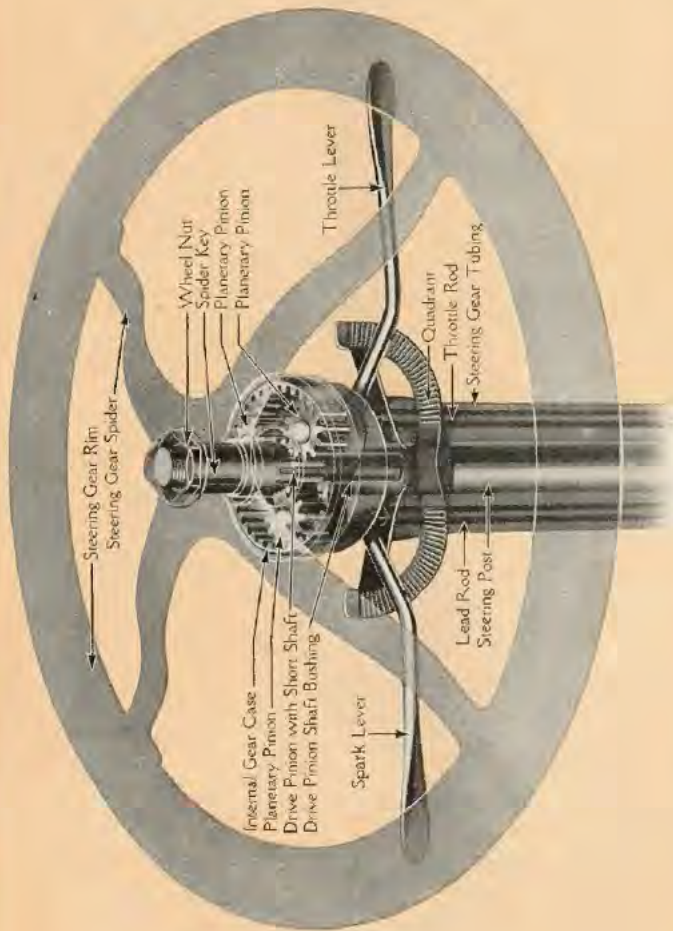

properly oiled when it leaves the factory. However, it will be well to see that all grease cups are filled and that oil is supplied to necessary parts (see Cut No. 20, also chapter on Lubrication).

How are Spark and Throttle Levers used?

Answer No. 4

Under the steering wheel are two small levers. The right-hand (throttle) lever controls the amount of mixture (gasoline and air) which goes into the engine. When the engine is in operation, the farther this lever is moved downward toward the driver (referred to as "opening the throttle") the faster the engine runs and the greater the power furnished. The left-hand lever controls the spark, which explodes the gas in the cylinders of the engine. The advancing of this lever "advances the spark," and it should be moved down notch by notch until the motor seems to reach its maximum speed. If the lever is advanced beyond this point a dull knock will be noticed in the engine. (See chapter on Ignition.)

Where should these levers be when the Engine is ready to crank?

Answer No. 5

The spark lever should usually be put in about the third or fourth notch of the quadrant (the notched half-circle on which the levers operate). The throttle should usually be opened about five or six notches. A little experience will soon teach you where these levers should be placed for proper starting. Care should be taken not to advance the spark lever too far, as the engine may "back kick."

What else is necessary before cranking the Engine?

Answer No. 6

First, see that the hand lever, which comes up through the floor of the car at the left of the driver, is pulled back as far as it will go. The lever in this position holds the clutch in neutral and engages the hub brake, thus preventing the car moving forward when the engine is started. Second, after inserting the switch key in the switch on the coil box, throw the switch lever as far to the left as it will go—to the point marked "magneto." This switch connects the magneto with the engine. The engine can't be started until it is on—and the throwing off of this switch stops the engine. The next step is to crank the engine.

How is the Engine cranked?

Answer No. 7

By the lifting of the starting crank at the front of the car. Take hold of the handle and push firmly toward the car till you feel the crank ratchet engage, then lift upward with a quick swing. With a little experience this operation will become an easy matter. Don't, as a usual thing, crank downward against the compression—for then an early explosion may drive the handle vigorously backward. This does not mean, however, that it is not advisable, when the car is hard to start, to occasionally "spin" the engine by the use of the starting handle—but be sure the spark lever is retarded when spinning or cranking the engine against compression, otherwise a sudden back-

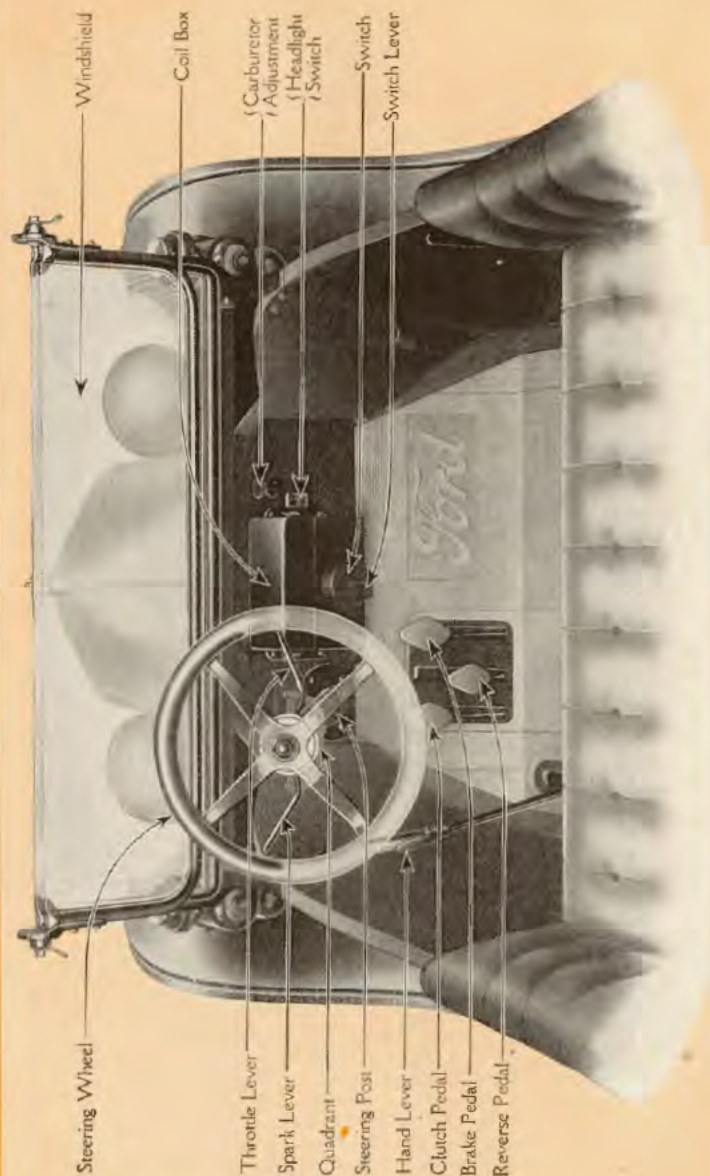

The Ford Control. (Cut No. 2)

fire may injure the arm of the operator. When the engine is cool it is advisable to prime the carburetor by pulling on the small wire at the lower left corner of the radiator while giving the engine two or three quarter turns with the starting handle.

How is the Engine best started in cold weather?

Answer No. 8

As gasoline does not vaporize readily in cold weather it is naturally more difficult to start the motor under such conditions. The usual method of starting the engine when cold is to turn the carburetor dash adjustment one-quarter turn to the left in order to allow a richer mixture of gasoline to be drawn into the cylinders; then hold out the priming rod, which projects through the radiator, while you turn crank from six to eight one-quarter turns in quick succession. Another method of starting a troublesome cold engine is as follows: Before you throw on the magneto switch, (1) close throttle lever; (2) hold out priming rod while you give crank several quick turns, then let go of priming rod (being careful that it goes back all the way); (3) place spark lever in about third notch and advance throttle lever several notches; (4) throw on switch (being sure to get it on side marked "Magneto"); (5) give crank one or two turns, and the motor should start. After starting the motor it is advisable to advance the spark eight or ten notches on the quadrant and let the motor run until thoroughly heated up. If you start out with a cold motor you will not have much power and are liable to "stall." The advantage of turning on the switch last, or after priming, is that when you throw on the switch and give the crank one-quarter turn, you have plenty of gas in the cylinders to keep the motor running, thereby eliminating the trouble of the motor starting and stopping. After motor is warmed up turn carburetor adjustment back one-quarter turn.

To facilitate starting many drivers make a practice of stopping their engine by walking around in front of the car and pulling out on the priming rod, which has the effect of shutting off the air suction and filling the cylinders full of a very rich gasoline vapor. This should not be done unless the car is going to stand over night or long enough to cool off. If the motor is stopped in this way and then started when hot, starting is apt to be difficult on account of the surplus gasoline in the carburetor.

How do the Foot Pedals operate?

Answer No. 9

The first one toward the left operates the clutch and by it the car is started and its operation largely controlled. When pressed forward the clutch pedal engages the low speed gear. When half-way forward the gears are in neutral (i. e., disconnected from the driving mechanism of the rear wheels), and, with the hand lever thrown forward, the releasing of this pedal engages the high-speed clutch. The center pedal operates the reverse clutch. The right-hand pedal operates the transmission brake. (See Cut No. 2.)

What function does the Hand Lever perform?*Answer No. 10*

Its chief purpose is to hold the clutch in neutral position. If it were not for this lever the driver would have to stop the engine whenever he left the driver's seat. He would also be unable to crank the engine without the car starting forward with the first explosion. When pulled back as far as it will go, the hand lever acts as an emergency brake on the rear wheels, by expanding the brake shoes in the rear wheel drums. Therefore the hand lever should be back as far as it will go when cranking the engine or when the car is at rest. It should be only in a vertical position, and not far enough backward to act as a brake on the rear wheels, when the car is to be reversed. When the car is operating in high or low speed the hand lever should be all the way forward.

How is the Car started?*Answer No. 11*

Slightly accelerate the engine by opening the throttle, place the foot on the clutch pedal, and thereby hold the gears in a neutral position while throwing the hand lever forward; then to start the car in motion, press the pedal forward into slow speed and when under sufficient headway (20 to 30 feet), allow the pedal to drop back slowly into high speed, at the same time partially closing the throttle, which will allow the engine to pick up its load easily. With a little practice the change of speeds will be easily accomplished, and without any appreciable effect on the smooth running of the machine.

How is the Car stopped?*Answer No. 12*

Partially close the throttle; release the high speed by pressing the clutch pedal forward into neutral; apply the foot brake slowly but firmly until the car comes to a dead stop. Do not remove foot from the clutch pedal without first pulling the hand lever back to neutral position, or the engine will stall. To stop the motor, open the throttle a trifle to accelerate the motor and then throw off the switch. The engine will then stop with the cylinders full of explosive gas, which will naturally facilitate starting. Endeavor to so familiarize yourself with the operation of the car that to disengage the clutch and apply the brake becomes practically automatic—the natural thing to do in case of emergency.

How is the Car reversed?*Answer No. 13*

It must be brought to a dead stop. With the engine running, disengage the clutch with the hand lever and press the reverse pedal forward with the left foot, the right foot being free to use on the brake pedal if needed. Do not bring the hand lever back too far or you will set the brakes on rear wheels. Experienced drivers ordinarily reverse the car by simply holding the clutch pedal in neutral with the left foot, and operating the reverse pedal with the right.

How is the Spark controlled?*Answer No. 14*

By the left-hand lever under the steering wheel. Good operators drive with the spark lever advanced just as far as the engine will permit. But if the spark is advanced too far a dull knock will be heard in the motor, due to the fact that the explosion occurs before the piston in the engine has completed its compression stroke. The best results are obtained when the spark occurs just at the time that piston reaches its highest point of travel—the gas being then at its highest point of compression. The spark should only be retarded when the engine slows down on a heavy road or steep grade, but care should be exercised not to retard the spark too far, for when the spark is "late," instead of getting a powerful explosion, a slow burning of the gas, with excessive heat, will result. Learn to operate the spark as the occasion demands. The greatest economy in gasoline consumption is obtained by driving with the spark advanced sufficiently to obtain the maximum speed.

How is speed of Car controlled?*Answer No. 15*

The different speeds required to meet road conditions are obtained by opening or closing the throttle. Practically all the running speeds needed for ordinary travel are obtained on high gear, and it is seldom necessary to use the low gear except to give the car momentum in starting. The speed of the car may be temporarily slackened in driving through crowded traffic, turning corners, etc., by "slipping the clutch," i. e., pressing the clutch pedal forward into neutral.

Is it advisable for owners to make their own Adjustments?*Answer No. 16*

The Ford is the simplest of all cars. Most of the ordinary adjustments an owner will soon learn to make for himself. But we most strongly recommend that when it becomes necessary to employ the services of a mechanic, the car be taken to a Ford mechanic—one of our own representatives who thoroughly understands the car—and who will have no motive for running up useless repair bills. The entire Ford organization is interested in keeping every individual Ford car in constant operation, at the lowest possible cost. We have known of much damage done to many cars by unskilled repair men.

What attention does the Car need?*Answer No. 17*

Remember that a new machine requires more careful attention during the first few days it is being driven than after the parts have become thoroughly "worked in." The car which is driven slowly and carefully when new usually gives the most satisfactory service in the end. Never start out with your car until you are sure that it has plenty of oil and water. Frequently inspect the running gear. See that no unnecessary play exists in either front or rear wheels, and that all bolts and nuts are tight. Make a practice of taking care of every repair or adjustment as soon as its necessity is discovered. This attention requires but little time and may avoid delay or possible accident on the road. We aim to deliver the car in proper mechanical adjustment. Afterwards it is plainly the duty of the driver to keep it in that condition.

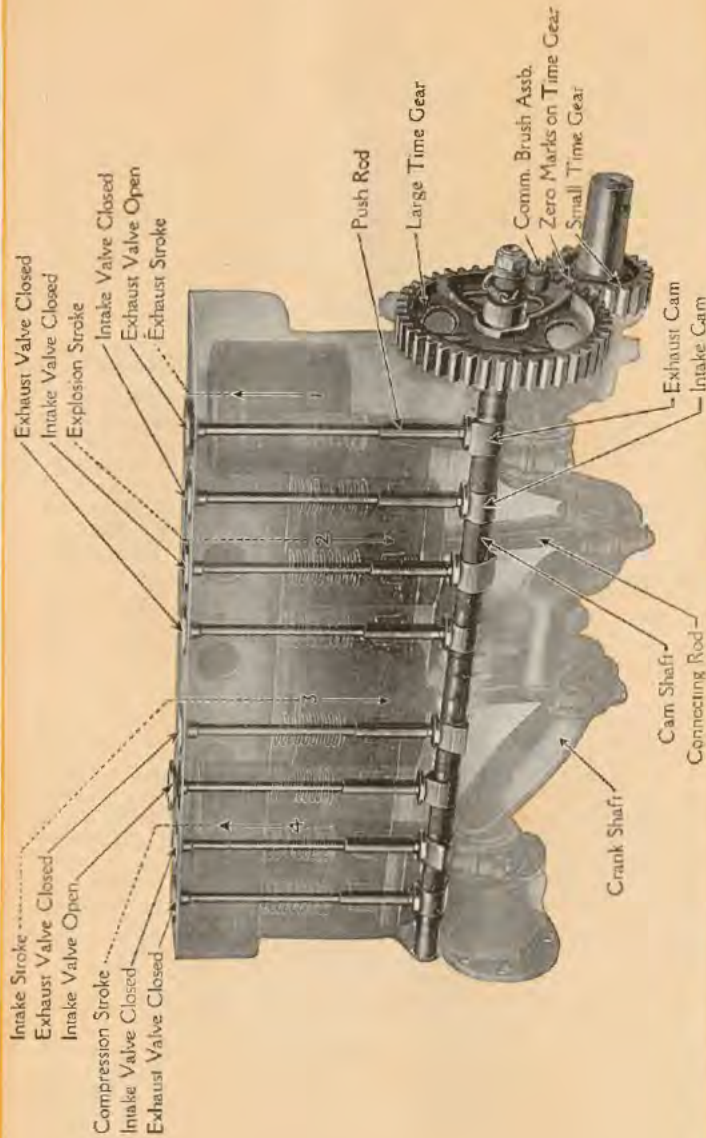

Cylinder Assembly, showing the correct position of the valves with time gears properly set according to punch marks on the gears, also the relative position of the pistons in their strokes as indicated above. The firing order of the cylinders is 1, 2, 4, 3. (Cut No. 4)

What about Valve timing?

Answer No. 22

In timing the engine the points of opening and closing of the valves are, of course, what should be considered. As the valves are properly timed at the factory when the engine is built the necessity for retiming would occur only when such parts as the cam shaft, time gears, or valves were removed in overhauling the engine.

In fitting the large time gear to the cam shaft it is important to see that the first cam points in a direction opposite to the zero mark (see Cut No. 4). The time gears must also mesh so that the tooth marked zero (0) on the small time gear will come between the two teeth on the large gear at the zero point. The time gears now being properly set, the exhaust valve on No. 1 cylinder is open and the intake valve closed, the other valves being in the position indicated in Cut No. 4. The opening and closing of the valves being as follows: The exhaust valve opens when the piston reaches $\frac{1}{16}$ " of bottom center, the distance from the top of the piston head to the top of the cylinder casting measuring $3\frac{3}{8}$ ". The exhaust valve will close on top center, the piston being $\frac{1}{16}$ " above the cylinder casting. The intake valve opens $\frac{1}{16}$ " after top center and closes $\frac{1}{16}$ " after bottom center, the distance from the top of the piston to the top of the cylinder casting measuring $3\frac{1}{8}$ ".

The clearance between the push rod and valve stem should never be greater than $\frac{1}{32}$ " nor less than $\frac{1}{64}$ ". The correct clearance is naturally half way between these two measurements. The gap should be measured when the push rod is on the heel of the cam.

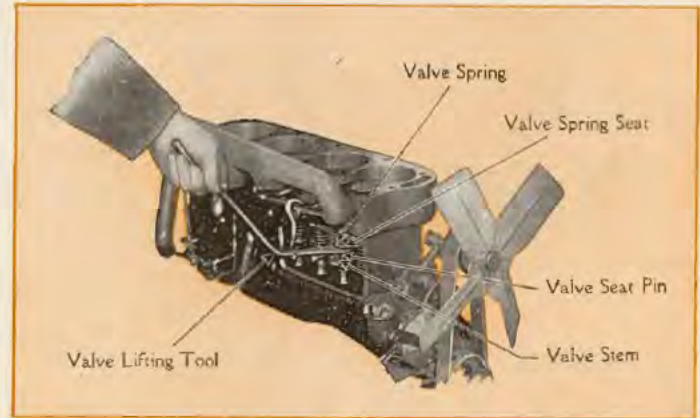

How the valve lifting tool should be used. (Cut No. 5)

What about the care of the Valves?

They seldom get out of order—but they do get dirty, as a result of carbon collecting on the valve seats. These carbon deposits, by preventing proper closing of the valves, permit the gases under compression to escape, resulting in loss of power and uneven running of the motor. If, when turning the engine over slowly, there is a lack of resistance in one or more cylinders, it is probable that the valves need re-grinding. As the "life" of the engine depends largely upon the proper seating of the valves, it is necessary that they be ground occasionally.

How are Valves removed for grinding?

(1) Drain radiator; (2) remove cylinder head; (3) remove the two valve covers on the right side of engine; (4) raise the valve spring with lifting tool (see Cut No. 5) and pull out the little pin under the valve seat. The valve may then be lifted out by the head—preparatory to grinding.

How are Valves ground?

For this work use a good grinding paste of ground glass and oil—procurable from auto supply houses. A convenient way is to put a small amount in a suitable dish, adding a spoonful or two of kerosene and a few drops of lubricating oil to make a thin paste.

Place the mixture sparingly on the bevel face of the valve. Put the valve in position on the valve seat, and rotate it back and forth (about a quarter turn) a few times, with a Ford grinding tool. Then lift slightly from the seat, change the position, and continue the rotation, and keep on repeating this operation until the bearing surface is smooth and bright. The valve should not be turned through a complete rotation, as this is apt to cause scratches running around the entire circumference of the valve and seat. When the grinding is completed the valve should be removed from the cylinder, thoroughly washed with kerosene, and the valve seat wiped out thoroughly.



Method of grinding valve. (Cut No. 6)

Extreme care should be taken that no abrasive substance gets into the cylinders or valve guides. This can be avoided if the grinding paste is applied sparingly to the bevel face of the valve.

Answer No. 23**Answer No. 24****Answer No. 25**

If the valve seat is worn badly or seamed, it is best to have it reseated with a valve seating tool. This operation requires considerable skill, and perhaps had better be done by an expert mechanic. Care should be exercised against making too deep a cut, necessitating the retiming of the valve.

When the Valves and Push Rods are worn—what?

When the valves or push rods become worn, so as to leave too much play between them, thus reducing the lift of the valves and diminishing the power of the motor, it is best to replace the push rods with new ones. The clearance between the push rod and the valve stem should never be greater than $\frac{1}{32}$ " nor less than $\frac{1}{64}$ ". If the clearance is greater, the valve will open late and close early, resulting in uneven running of the motor. If the clearance is less than $\frac{1}{64}$ " there is danger of the valve remaining partially open all the time. If replacing the push rod does not give the proper clearance, the valve should also be replaced. We do not recommend drawing out the valve stem, as the operation requires experience and the price of the new part does not warrant the time and expense necessary to properly do the work.

What about the Valve Springs?

When the valves fail to seat themselves properly, there is a possibility that the springs may be weak or broken. A weak inlet spring would probably not affect the running of the engine, but weakness in the exhaust valve spring causes a very uneven action, which is difficult to locate. The symptoms are a lag in the engine due to the exhaust valve not closing instantaneously, and as a result a certain percentage of the charge under compression escapes, greatly diminishing the force of the explosion. Weakness in a valve spring can usually be detected by the following method: Remove the plate which encloses them at the side of the cylinder and insert a screw-driver between the coils of the spring while the engine is running. If the extra tension thus produced causes the engine to pick up speed, the spring is obviously weak and should be replaced with a new one.

What causes "Knocking" in the Engine?

There are several causes, which may be enumerated as follows: (1) carbon knock—which is by far the most common—resulting from carbonizing of cylinders; (2) knock caused by a too advanced spark; (3) connecting rod knock; (4) crank shaft main bearing knock; (5) knock due to loose-fitting piston or broken ring; (6) knock caused by the piston striking the cylinder head gasket. When the engine knocks from any cause whatsoever, the matter should be promptly investigated by an experienced mechanic and the difficulty corrected.

Answer No. 26**Answer No. 27****Answer No. 28**

How may the different Knocks be distinguished?

(1) The carbon knock is a clear, hollow sound, most noticeable in climbing sharp grades, particularly when the engine is heated. It is also indicated by a sharp rap immediately on advancing the throttle. (2) Too advanced spark will be indicated by a dull knock in the motor. (3) The connecting rod knock sounds like the distant tapping of steel with a small hammer, and is readily distinguished when the car is allowed to run idly down grade—or upon speeding the car to twenty-five miles an hour, then suddenly closing the throttle, the tapping will be very distinct. (4) The crank shaft main bearing knock can be distinguished, when the car is going uphill, as a dull thud. (5) The loose piston knock is heard only upon suddenly opening the throttle, when the sound produced might be likened to a rattle. The remedies for these knocks are treated under their proper division.

How is carbon removed from Combustion Chamber?

First, drain the water off by opening the pet cock at the bottom of the radiator; then disconnect the wires at the top of the motor and also the radiator connection attached to the radiator. Remove the 15 cap screws which hold the cylinder head in place. Take off the cylinder head and, with a putty knife or screw-driver, scrape from the cylinder and piston heads the carbonized matter, being careful to prevent the specks of carbon from getting into the cylinders or bolt holes. In replacing the cylinder head gasket turn the motor over so that No. 1 and No. 4 pistons are at top center; place the gasket in position over the pistons and then put the cylinder head in place. Be sure and draw the cylinder head bolts down evenly (i. e., give each bolt a few turns at a time); do not tighten them on one end before drawing them up at the other.

How are Spark Plugs cleaned?

After removing the plug from the engine the points may be cleaned with an old tooth-brush dipped in gasoline. However, in order to do the work thoroughly, the plug should be taken apart by securing the large hexagon steel shell in a vise and loosening the pack nut which holds the porcelain in place. The carbon deposits can then be easily removed from the porcelain and shell with a small knife. Care should be exercised not to scrape off the glazed surface of the porcelain, otherwise it will be apt to carbonize quickly. The porcelain and other parts should finally be washed in gasoline and wiped dry with a cloth.

In assembling the plug care should be taken to see that the pack nut is not tightened too much so as to crack the porcelain, and the distance between the sparking points should be $\frac{3}{32}$ " , about the thickness of a smooth dime.

Dirty plugs usually result from an excess of oil being carried in the crank case—or from using oil of poor quality.

*Answer No. 29**Answer No. 30**Answer No. 31***How is the Power Plant removed from Car?**

- (1) Drain the water out of the radiator and disconnect the radiator hose;
- (2) disconnect the radiator stay rod which holds it to the dash;
- (3) take out the two bolts which fasten the radiator to the frame and take radiator off;
- (4) disconnect the dash at the two supporting brackets which rest on the frame;
- (5) loosen the steering post bracket, fastened to the frame, when the dash and steering gear may be removed as one assembly—the wires first having been disconnected;
- (6) take out the bolts holding the front radius rods in the socket underneath the crank case;
- (7) remove the four bolts at the universal joint;
- (8) remove pans on either side of cylinder casting and turn off gasoline, disconnect feed pipe from carburetor;
- (9) disconnect exhaust manifold from exhaust pipe by unscrewing large brass pack nut;
- (10) take out the two cap screws which hold the crank case to the front frame;
- (11) remove the bolts which hold the crank case arms to the frame at the side. Then pass a rope through the opening between the two middle cylinders and tie in a loose knot. Through the rope pass a "2x4," or a stout iron pipe about ten feet long, and let a man hold each end; let a third man take hold of the starting crank handle, when the whole power plant can be lifted from the car to the work bench for adjustment.

Connecting Rod Bearings—how adjusted?

Connecting rod bearings may be adjusted, without taking out the engine, by the following method; (1) drain off the oil; (2) remove plate on bottom of crank case—exposing connecting rods; (3) take off first connecting rod cap, and draw-file the ends—a very little at a time; (4) replace cap, being careful to see that punch marks correspond, and tighten bolts until it fits shaft snugly; (5) test tightness of bearing by turning engine over by the starting handle. Experienced mechanics usually determine when the bearing is properly fitted by lightly tapping each side of the cap with a hammer; (6) then loosen the bearing and proceed to fit the other bearings in the same manner; (7) after each bearing has been properly fitted and tested—then tighten the cap bolts and the work is finished.

Remember, there is a possibility of getting the bearings too tight, and under such conditions the babbit is apt to cut out quickly, unless precaution is taken to run the motor slowly at the start. It is a good plan after adjusting the bearings to jack up the rear wheels and let the motor run slowly for about two hours (keeping it well supplied with water and oil) before taking it out on the road. Whenever possible these bearings should be fitted by an expert Ford mechanic.

*Answer No. 32**Answer No. 33*

Worn connecting rods may be returned, prepaid, to the nearest agent or branch house for exchange at a price of 75 cents each to cover the cost of rebabbiting. It is not advisable for any owner or repair shop to attempt the rebabbiting of connecting rods or main bearings, for without a special jig in which to form the bearings, satisfactory results will not be obtained. The constant tapping of a loose connecting rod on the crank shaft will eventually produce crystallization of the steel—result, broken crank shaft and possibly other parts of the engine damaged.

Crank Shaft Main Bearings —how adjusted?

Answer No. 34

Should the stationary bearings in which the crank shaft revolves become worn (evidenced by a pounding in the motor) and need replacing or adjusting, proceed as follows:

(1) After the engine has been taken out of the car, remove crank case, transmission cover, cylinder head, pistons, connecting rods, transmission and magneto coils. Take off the three babbitted caps and clean the bearing surfaces with gasoline. Apply Persian blue or red lead to the crank shaft bearing surfaces, which will enable you, in fitting the caps, to determine whether a perfect bearing surface is obtained.

(2) Place the rear cap in position and tighten it up as much as possible without stripping the bolt threads. When the bearing has been properly fitted, the crank shaft will permit moving with one hand. If the crank shaft cannot be turned with one hand, the contact between the bearing surfaces is evidently too close, and the cap requires shimming up, one or two brass liners usually being sufficient. In case the crank shaft moves too easily with one hand, the shims should be removed and the steel surface of the cap filed off, permitting it to set closer.

(3) After removing the cap, observe whether the blue or red "spottings" indicate a full bearing the length of the cap. If "spottings" do not show a true bearing, the babbitt should be scraped and the cap refitted until the proper results are obtained.

(4) Lay the rear cap aside and proceed to adjust the center bearing in the same manner. Repeat the operation with the front bearing, with the other two bearings laid aside.

(5) When the proper adjustment of each bearing has been obtained, clean the babbitt surface carefully and place a little lubricating oil on the bearings, also on the crank shaft; then draw the caps up as closely as possible—the necessary shims, of course, being in place. Do not be afraid of getting the cap bolts too tight, as the shim under the cap and the oil between the bearing surfaces will prevent the metal being drawn into too close contact. If oil is not put on the bearing surfaces, the babbitt is apt to cut out when the motor is started up before the oil in the crank case can get into the bearing. In replacing the crank case and transmission cover on the motor, it is advisable to use a new set of felt gaskets to prevent oil leaks.

The Ford Cooling System

How is the Engine cooled?

Answer No. 35

The heat generated by the constant explosions in the engine would soon overheat and ruin the engine, were it not cooled by some artificial means. The Ford engine is cooled by the circulation of water in jackets around the cylinders. The heat is extracted from the water by its passage through the thin metal tubing of the radiator—to which are attached scientifically worked out fins, which assist in the rapid radiation of the heat. The fan, just back of the radiator, sucks the air around the tubing—through which the air is also driven by the forward movement of the car. The belt should be inspected frequently and tightened when necessary—not too tight, however—by means of the adjusting screw in the fan bracket. Take up the slack till the fan starts to bind when turned by hand.

How does the Water circulate?

Answer No. 36

The cooling apparatus of the Ford car is known as the Thermosiphon system. It acts on the principle that hot water seeks a higher level than cold water—consequently when the water reaches a certain heat, approximately 180 degrees Fahrenheit, circulation commences and the water flows from the lower radiator outlet pipe up through the water jackets, into the upper radiator water tank, and down through the tubes to the lower tank, to repeat the process.

What are the causes of Overheating?

Answer No. 37

(1) Carbonized cylinders; (2) too much driving on low speed; (3) spark retarded too far; (4) poor ignition; (5) not enough or poor grade oil; (6) racing motor; (7) clogged muffler; (8) improper carburetor adjustment; (9) fan not working properly on account of broken or slipping belt; (10) improper circulation of water due to clogged or jammed radiator tubes, leaky connections or low water.

What should be done when the Radiator overheats?

Answer No. 38

Keep the radiator full. Don't get alarmed if it boils occasionally—especially in driving through mud and deep sand or up long hills in extremely warm weather. Remember that the engine develops the greatest efficiency when the water is heated nearly to the boiling point. But if there is persistent overheating when the motor is working under ordinary conditions—find the cause of the trouble and remedy it. The chances are that the difficulty lies in improper driving or carbonized cylinders. Perhaps twisting the fan blades at a greater angle to produce more suction may bring desired results. By reference to the proper division of this book each of the causes which contribute to an overheated radiator is treated and remedies suggested. No trouble can result from the filling of a heated radiator with cold water—providing the water system is not entirely empty—in which case the motor should be allowed to cool before the cold water is introduced.

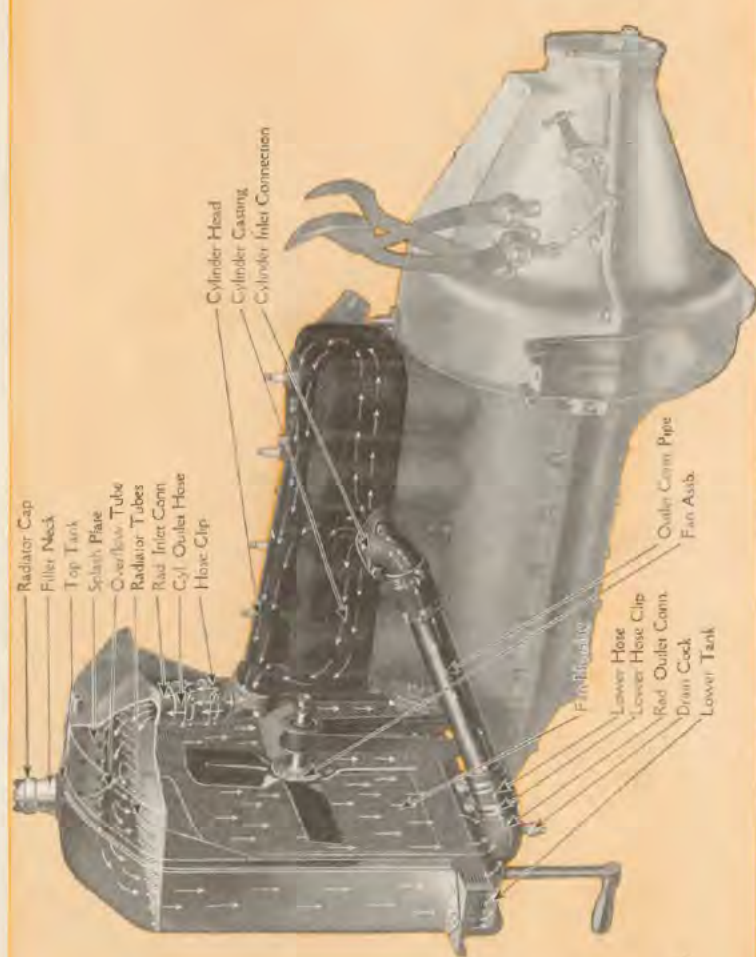

The Thermo-Syphon Cooling System, showing course of water through water passages. (Cut No. 7)

How about cleaning the Radiator?

Answer No. 39

The entire circulating system should be thoroughly flushed out occasionally. To do this properly, the radiator inlet and outlet hose should be disconnected, and the radiator flushed out by allowing the water to enter the filler neck at ordinary pressure, from whence it will flow down through the tubes and out at the drain cock and hose. The water jackets can be flushed out in the same manner. Simply allow the water to enter into the cylinder head connection and to flow through the water jackets and out at the side inlet connection.

Will the Radiator freeze in winter?

Answer No. 40

Yes, unless an anti-freezing solution is used in the circulating system you are bound to experience trouble. As the circulation does not commence until the water becomes heated, it is apt to freeze at low temperature before it commences to circulate. In case any of the radiator tubes happen to be plugged or jammed they are bound to freeze and burst open if the driver undertakes to get along without using a non-freezing solution. Wood or denatured alcohol can be used to good advantage. The following table gives the freezing points of solutions containing different percentages of alcohol:

20%	solution freezes at 15 degrees above zero.
30%	solution freezes at 8 degrees below zero.
50%	solution freezes at 34 degrees below zero.

A solution composed of 60% water, 10% glycerine and 30% alcohol is commonly used, its freezing point being about 8 degrees below zero. On account of evaporation fresh alcohol must be added frequently in order to maintain the proper solution.

How are leaks and jams in the Radiator repaired?

Answer No. 41

A small leak may be temporarily repaired by applying brown soap or white lead—but the repair should be made permanent with solder as soon as possible. A jammed radiator tube is a more serious affair. While the stopping of one tube does not seriously interfere with the circulation, it is bound to cause trouble sooner or later—and the tube will freeze in cold weather. Cut the tube an inch above and below the jam and insert a new piece, soldering the connections. If the entire radiator is badly jammed or broken it would probably be advisable to install a new one.



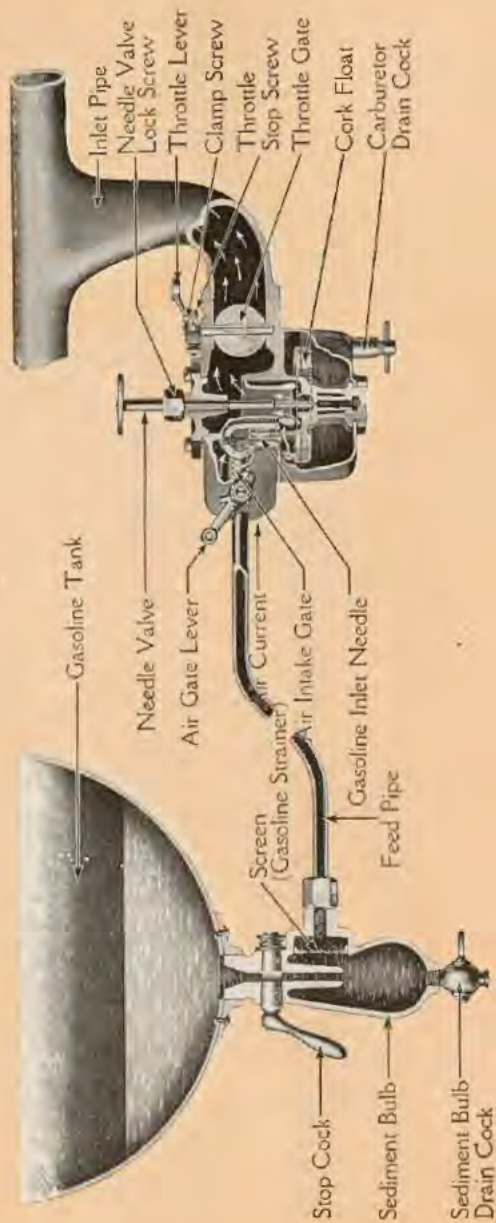

This cut illustrates the principle of Ford Carburetion. (Cut No. 8)

The Gasoline System

The Carburetor. How does it work?

Answer No. 42

The carburetor is of the automatic float feed type, having but one adjustment—the gasoline needle valve. The cross-section diagram of carburetor on page 22 shows how the gasoline enters the carburetor, is vaporized by a current of air and passes through the inlet pipe to the engine in the form of an explosive mixture. The gasoline, entering the bowl of the carburetor, gradually raises the float to a point where the inlet needle is forced upwards into its seat, thus cutting off the flow of gasoline. As the gasoline in the bowl recedes, the float lowers, allowing the needle to drop from its seat and the flow of gasoline is resumed. It is plain to see that a constant level of gasoline is maintained in the carburetor by the automatic action of float and needle. The quantity of gasoline entering into the mixture is governed by the needle valve (see Answer No. 45). The volume of gas mixture entering the intake pipe is controlled by opening and closing the throttle, according to the speed desired by the driver.

Why is Carburetor adjustment placed on dash?

Answer No. 43

For the convenience of the driver in adjusting the carburetor. After the new car has become thoroughly worked in, the driver should observe the angle of the carburetor adjusting rod at which the engine runs most satisfactorily. In cold weather it will probably be found necessary to turn the dash adjustment one-quarter turn to the left, particularly in starting a cold engine. As gasoline vaporizes readily in warm weather, the driver will find it economical to reduce the quantity of gasoline in the mixture by turning the carburetor adjustment to the right as far as possible without reducing speed. This is particularly true when taking long drives where conditions permit a fair rate of speed being maintained, and accounts for the excellent gasoline mileage obtained by good drivers.

What is meant by a "lean" and a "rich" Mixture?

Answer No. 44

A lean mixture has too much air and not enough gasoline. A rich mixture has too much gasoline and not enough air. A rich mixture will not only quickly cover the cylinders, pistons and valves with soot, but will tend to overheat the cylinders, and is likewise wasteful of the fuel. It will often choke the engine and cause misfiring at slow speeds, although at high speeds the machine will run perfectly. The mixture should be kept as lean as possible without the sacrifice of any of the power of the motor. A lean mixture will often result in back-firing through the carburetor, for the reason that the gas burns slowly in the cylinder, and is still burning when the inlet valve opens again, which causes the gas in the intake to ignite. A rich mixture is shown by heavy, black exhaust smoke with a disagreeable smell. Proper mixture will cause very little smoke or odor.

How is the Carburetor adjusted?*Answer No. 45*

The usual method of regulating the carburetor is to start the motor, advancing the throttle lever to about the sixth notch, with the spark retarded to about the fourth notch. The flow of gasoline should now be cut off by screwing the needle valve down to the right until the engine begins to misfire, then gradually increase the gasoline feed by opening the needle valve until the motor picks up and reaches its highest speed and no trace of black smoke comes from the exhaust. Whenever it is necessary to turn the adjusting needle down more than a quarter turn below its normal position, the lock nut on top of the carburetor at the point through which needle passes should first be loosened, as otherwise it is impossible to tell when the needle is turned down in its seat too far. Turning the needle down too tightly will result in its becoming grooved and the seat enlarged. When these parts are damaged it is difficult to maintain proper adjustment of the carburetor. Having determined the point where the motor runs at its maximum speed, the needle valve lock nut should be tightened to prevent the adjustment being disturbed. For average running, a lean mixture will give better results than a rich one.

Why does water clog the Carburetor?*Answer No. 46*

The presence of water in the carburetor or gasoline tank, even in small amounts, will prevent easy starting and the motor will misfire and stop. As water is heavier than gasoline it settles to the bottom of the tank and into the sediment bulb along with other foreign matter. As it is difficult nowadays to get gasoline absolutely free from impurities, especially water, it is advisable to frequently drain the sediment bulb under the gasoline tank. During cold weather the water which accumulates in the sediment bulb is likely to freeze and prevent the flow of gasoline through the pipe leading to the carburetor. Should anything of this kind happen it is possible to open the gasoline line by wrapping a cloth around the sediment bulb and keeping it saturated with hot water for a short time. Then the water should be drained off. In event the water gets down into the carburetor and freezes, the same treatment may be applied.

What makes the Carburetor leak?*Answer No. 47*

The flow of gasoline entering the carburetor through the feed pipe is automatically regulated by the float needle raising and lowering in its seat. Should any particle of dirt become lodged in the seat, which prevents the needle from closing, the gasoline will overflow in the bowl of the carburetor and leak out upon the ground.

When there is dirt in the Carburetor—what?*Answer No. 48*

The spraying nozzle of the carburetor having a very small opening, a minute particle of grit or other foreign matter will clog up the orifice, and result: motor will begin to misfire and slow down as soon as it has attained any considerable speed. This is accounted for by the

fact that at high speeds the increased suction will draw the particles of dust, etc., into the nozzle. By opening the valve needle half a turn and giving the throttle lever two or three quick pulls the dirt or sediment will often be drawn through, when the needle may be turned back to its original place. If this does not accomplish the purpose, the carburetor should be drained.

If Engine runs too fast or chokes with throttle retarded—what?*Answer No. 49*

If the engine runs too fast with throttle fully retarded unscrew the carburetor throttle lever adjusting screw until the engine idles at suitable speed. If the motor chokes and stops when throttle is fully retarded, the adjusting screw should be screwed in until it strikes the boss, preventing the throttle from closing too far. When proper adjustment has been made, tighten lock-screw so that adjustment will not be disturbed.

What is the purpose of the Hot Air Pipe?*Answer No. 50*

It takes the hot air from around the exhaust pipe and conducts it to the carburetor—where the heat facilitates the vaporizing of the gasoline. It is usually advisable to remove this pipe in the hot season—but it is an absolutely necessary feature during cold weather.

What is the purpose of the Cork Float?*Answer No. 51*

It automatically controls the flow of the gasoline into the carburetor. If it floats too low, starting will be difficult; if too high, the carburetor will flood and leak. A cork float which has become fuel soaked should be removed and replaced by a new one or thoroughly dried and then given a couple of coats of shellac varnish to make it waterproof.

Should Priming Rod be used in cranking when Motor is warm?*Answer No. 52*

No. The carburetor does not ordinarily require priming when the motor is warm, and cranking with the rod pulled out is apt to "flood" the engine with an over-rich mixture of gas, which does not readily explode. This naturally causes difficulty in starting. If you should accidentally flood the engine, turn the carburetor adjusting needle down (to the right) until it seats; then turn the engine over a few times with the starting crank in order to exhaust the rich gas. As soon as the motor starts, turn back the needle (to the left) and re-adjust the carburetor.



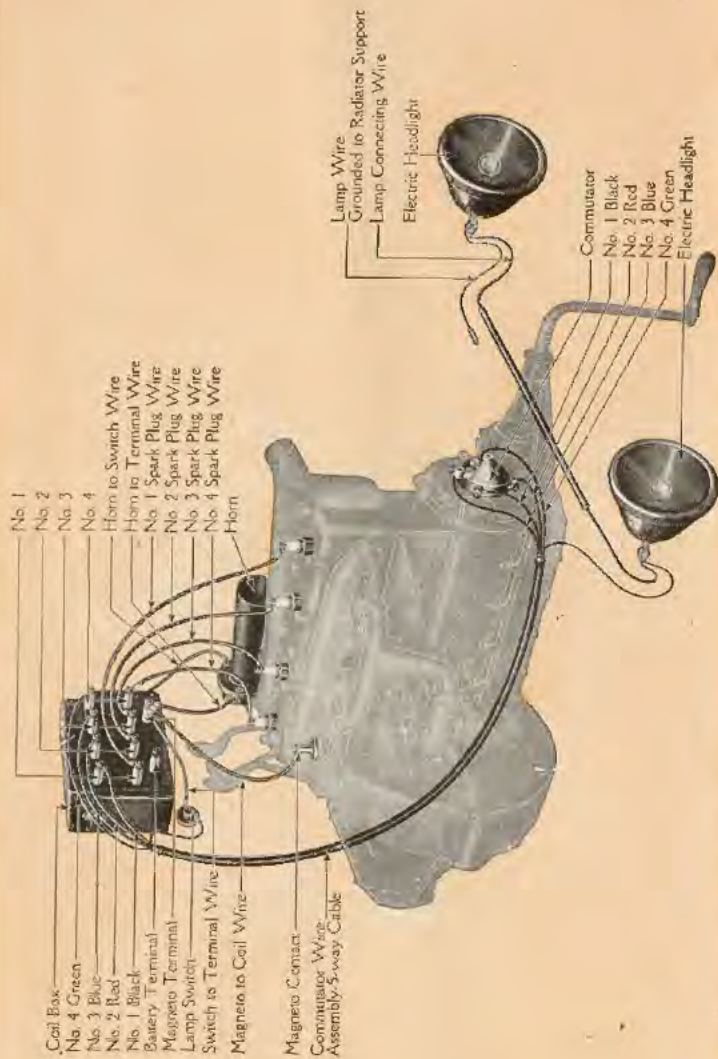

Wiring of Ford Ignition System. (Cut No. 10)

The Ford Ignition System

What is the purpose of the Ignition System?

Answer No. 53

It furnishes the electric spark which explodes the charge in the combustion chamber, thus producing the power which runs the engine. It is important that the charge be correctly ignited at the proper time, in order to obtain satisfactory results in running the car. In the Ford car the ignition system is as simple as it is possible for human invention to make it.

How does the Magneto generate the current?

Answer No. 54

In revolving at the same rate of speed as the motor, the magnets on the flywheel passing the stationary coil spools create an alternating low tension electric current in coils of wire which are wound around spools fastened to the stationary part of the magneto, and is carried from these coils to the magneto connection (wire) leading to the coil box on the dash.

Should the Coil Vibrator Adjustment be disturbed?

Answer No. 55

The present style of coil unit is properly adjusted when it leaves the factory and this adjustment should not be disturbed unless to install new points or to reduce the gap between the points which may have increased from wear. When adjustments are necessary they should, whenever possible, be made by one of our service stations who have special equipment for testing and adjusting units and will gladly furnish expert service. If the points are pitted they should be filed flat with a fine double-faced file and the adjusting thumb nut turned down so that with the spring held down the gap between the points will be a trifle less than $\frac{1}{32}$ of an inch. Then set the lock nut so that the adjustment can not be disturbed. Do not bend or hammer on the vibrators, as this would affect the operation of the cushion spring of the vibrator bridge and reduce the efficiency of the unit.

How is a Weak Unit detected?

Answer No. 56

With the vibrators properly adjusted, if any particular cylinder fails or seems to develop only a weak action, change the position of the unit to determine if the fault is actually in the unit. The first symptom of a defective unit is the buzzing of the vibrator with no spark at the plug. Remember that a loose wire connection, faulty spark plug, or worn commutator may cause irregularity in the running of the motor. These are points that should be considered before laying the blame on the coil.

How may short circuit in Commutator Wiring be detected?

Answer No. 57

Should the insulation of the primary wires (running from coil to commutator) become worn to such an extent that the copper wire is exposed—the current will leak out (i. e., short circuit) whenever

contact with the engine pan or other metal parts is made. A steady buzzing of one of the coil units will indicate a "short" in the wiring. When driving the car the engine will suddenly lag and pound on account of the premature explosion. Be careful not to crank the engine downward against compression when the car is in this condition, as the "short" is apt to cause a vigorous kick back.

Does Coil Adjustment affect starting?

Answer No. 58

Yes. When the vibrators are not properly adjusted more current is required to make and break the contact between the points, and, as a result, at cranking speeds you would not get a spark between the spark plug points. Do not allow the contact points to become "ragged," otherwise they are apt to stick and cause unnecessary difficulty in starting, and when running they are apt to produce an occasional "miss" in the engine.

What is the purpose of the Commutator?

Answer No. 59

The commutator (or timer) determines the instant at which the spark plugs must fire. It effects the "make and break" in the primary circuit. The grounded wire in the magneto allows the current to

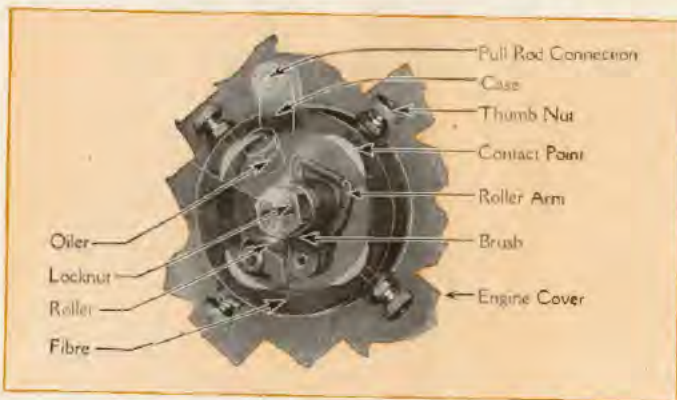

The Ford Commutator. (Cut No. 11)

flow through the metal parts to the metal roller in the commutator. Therefore, when the commutator roller in revolving touches the four commutator contact points, to each of which is attached a wire connected with a coil unit, an electrical circuit is passed through the entire system of primary wires. This circuit is only momentary, however, as the roller passes over the contact point very rapidly and sets up the circuit in each unit as the roller touches the contact point connected with that unit. The commutator should be kept clean and well oiled at all times.

What about the Spark Plugs?

Answer No. 60

One is located at the top of each cylinder and can easily be taken out with the spark plug wrench included with every car, after the wire connection is removed. The high voltage current flows out of the secondary coils in the coil box and on reaching the contact points in each spark plug it is forced to jump a $\frac{3}{32}$ " gap, thereby forming a spark which ignites the gasoline charge in the cylinders.

The spark plugs should be kept clean (i. e., free from carbon) and should be replaced if they persist in not working properly. There is nothing to be gained by experimenting with different makes of plugs. The make of plugs with which Ford engines are equipped when they leave the factory are best adapted to the requirements of our motor, notwithstanding the opinion of various garage men to the contrary. All wire connections to spark plugs, coil box and commutator should, of course, at all times be kept in perfect contact.

What are the indications of Ignition trouble?

Answer No. 61

The uneven sputter and bang of the exhaust means that one or more cylinders are exploding irregularly or not at all, and that the trouble should be promptly located and overcome. Misfiring, if allowed to continue, will in time injure the engine and the entire mechanism. If you would be known as a good driver you will be satisfied only with a soft, steady purr from the exhaust. If anything goes wrong, stop and fix it if possible—don't wait until you get home.

How can one tell which Cylinder is missing?

Answer No. 62

This is done by manipulating the vibrators on the spark coils. Open the throttle until the engine is running at a good speed and then hold down the two outside vibrators, No. 1 and No. 4, with the fingers, so they cannot buzz. This cuts out the two corresponding cylinders, No. 1 and No. 4, leaving only No. 2 and No. 3 running. If they explode regularly it is obvious the trouble is in either No. 1 or No. 4. Relieve No. 4 and hold down No. 2 and No. 3 and also No. 1; if No. 4 cylinder explodes evenly it is evident the misfiring is in No. 1. In this manner all of the cylinders in turn can be tested until the trouble is located. Examine both the spark plug and the vibrator of the missing cylinder.

If the Coil and Plug are right—what?

Answer No. 63

The trouble is probably due to an improperly seated valve, worn commutator, or short circuit in the commutator wiring. Weakness in the valves may be easily determined by lifting the starting crank slowly the length of the stroke of each cylinder in turn, a strong or weak compression in any particular valve being easily detected. It sometimes happens that the cylinder head gasket (packing) becomes leaky—permitting the gas under compression to escape, a condition that can be detected by running a little lubricating oil around the edge of the gasket and noticing whether bubbles appear or not.

Does a worn Commutator ever cause misfiring?**Answer No. 64**

Yes. If misfiring occurs when running at high speed, inspect the commutator. The surface of the circle around which roller (see Cut No. 11) travels should be clean and smooth, so that the roller makes a perfect contact at all points. If the roller fails to make a good contact on any one of the four contact points, its corresponding cylinder will not fire. Clean these surfaces, if dirty. In case the fibre, contact points and roller of the commutator are badly worn the most satisfactory remedy is to replace them with new parts, or probably the trouble is caused by short-circuited commutator wires. The spring should be strong enough to make a firm contact between the roller points if they are worn or dirty.

How is the Commutator removed?**Answer No. 65**

Remove cotter pin from spark rod and detach latter from commutator. Loosen the cap screw which goes through breather pipe on top of time gear cover. This will release the spring which holds the commutator case in place and this part can be readily removed. Unscrew lock nut; withdraw steel brush cap and drive out the retaining pin. The brush can then be removed from the cam shaft. In replacing the brush, care must be exercised to see that it is reinstated so that the exhaust valve on the first cylinder is closed when the brush points upward. This may be ascertained by removing the valve door and observing the operation of No. 1 valve.

Does cold weather affect the Commutator?**Answer No. 66**

It is a well known fact that in cold weather even the best grades of lubricating oil are apt to congeal to some extent. If this occurs in the commutator it is very apt to prevent the roller from making perfect contact with the contact points imbedded in the fibre. This, of course, makes difficult starting, as the roller arm spring is not stiff enough to brush away the film of oil which naturally forms over the contact points. To overcome this, as well as any liability of the contact points to rust, we recommend a mixture of 25% kerosene with the commutator lubricating oil, which will thin it sufficiently to prevent congealing, or freezing, as it is commonly called. You have probably noticed in starting your car in cold weather that perhaps only one or two cylinders will fire for the first minute or so, which indicates that the timer is in the condition described above and as a consequence a perfect contact is not being made on each of the four terminals.

How is the Magneto removed?**Answer No. 67**

It is necessary to take the power plant out of the car (see Answer No. 32) in order to remove the magneto. Then remove crank case and transmission cover—take out the four cap screws that hold the flywheel to the crank shaft. You will then have access to the magnets and entire magneto mechanism. In taking out these parts—or any parts of the car—the utmost care should be taken to make sure that the parts are so marked that they may be replaced properly.

When the Magneto gets out of order—what?**Answer No. 68**

The Ford magneto is made of permanent magnets and there is very little likelihood of their ever losing their strength, unless acted upon by some outside force. For instance, the attachments of a storage battery to the magneto terminal will demagnetize the magnets. If anything like this happens, it is not advisable to try to recharge them, but rather install a complete set of new magnets. The new magnets will be sent from the nearest agent or branch house, and will be placed on a board in identically the same manner as they should be

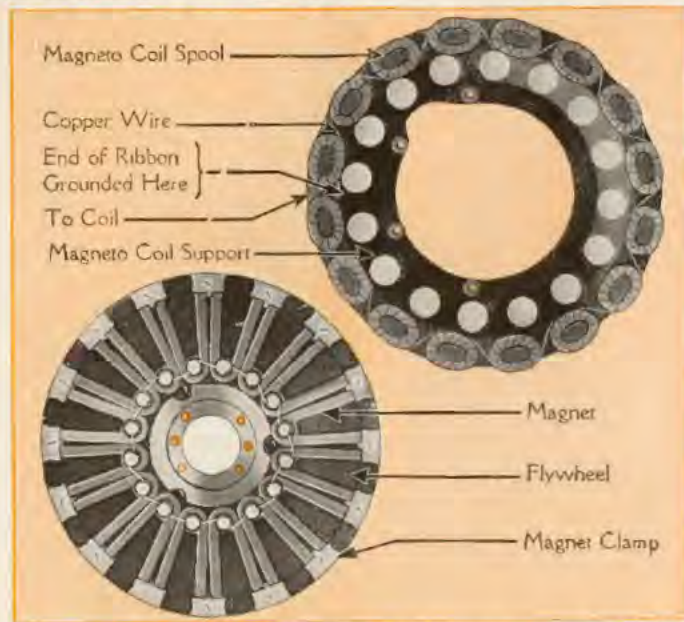

The Ford Magneto. The flywheel with magnets revolves with the engine, while magneto coils remain stationary. (Cut No. 12)

when installed on the flywheel. Great care should be taken in assembling the magnets and lining up the magneto so that the faces of the magnets are separated from the surface of the coil spool just $\frac{1}{2}$ of an inch. To take out the old magnets, simply remove the cap screw and bronze screw which holds each in place. The magneto is often blamed when the trouble is a weak current caused by waste or other foreign matter accumulating under the contact spring, which is held in place by the binding post on top of the crank case cover. Remove the three screws which hold the binding post in place, remove binding post and spring and replace after foreign substance has been removed.

The Ford Transmission

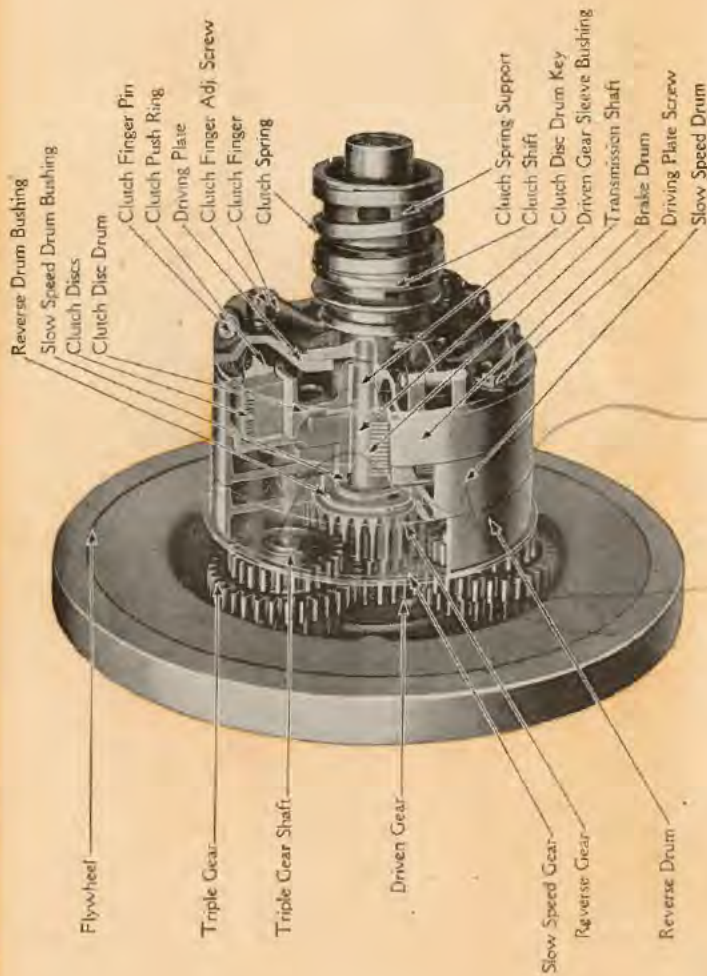

Transmission, showing all gears in mesh. (Car No. 13)

What is the function of the Transmission?

Answer No. 69

It is that part of the mechanism of an automobile which lies between the engine shaft and the propeller shaft and by which one is enabled to move at different speeds from the other. It is the speed gear of the car. It sends the car forward at low and high speeds and by it the car is reversed.

What is meant by the term "Planetary Transmission"?

Answer No. 70

One in which the groups of gears always remain in mesh and revolve around a main axis. The different sets of gears are brought into action by stopping the revolution of the parts which support the gears. By means of bands (similar to brake bands) the rotation of the different parts is stopped. The planetary transmission is the simplest and most direct means of speed control—and is a distinct advantage of the Ford car.

What is the purpose of the Clutch?

Answer No. 71

If the crank shaft of the engine ran without break straight through to the differential—and through it applied its power direct to the rear wheels—the car would start forward immediately upon the starting of the engine (were it possible to get it started under such conditions). To overcome this difficulty the shaft is divided and by means of the clutch the part of the shaft to which the running engine is delivering its power is enabled to take hold of the unmoving part gradually and start the car without jolt or jar. The forward part of the shaft is referred to as the crank shaft, the rear part as the drive shaft.

How is the Clutch controlled?

Answer No. 72

By the left pedal at the driver's feet (see Answer No. 9). If the clutch pedal, when pushed forward into slow speed, has a tendency to stick and not to come back readily into high, tighten up the slow speed band as directed in Answer No. 74. Should the machine have an inclination to creep forward when cranking, it indicates that the clutch lever screw which bears on the clutch lever cam has worn, and requires an extra turn to hold the clutch in neutral position. When the clutch is released by pulling back the hand lever the pedal should move forward a distance of $1\frac{3}{4}$ " in passing from high speed to neutral. See that the hub brake shoe and connections are in proper order so that the brake will act sufficiently to prevent the car creeping very far ahead. Also be sure the slow speed band does not bind on account of being adjusted too tight. Don't use a too heavy grade of oil in cold weather, as it will have a tendency to congeal between the clutch discs and prevent proper action of the clutch.

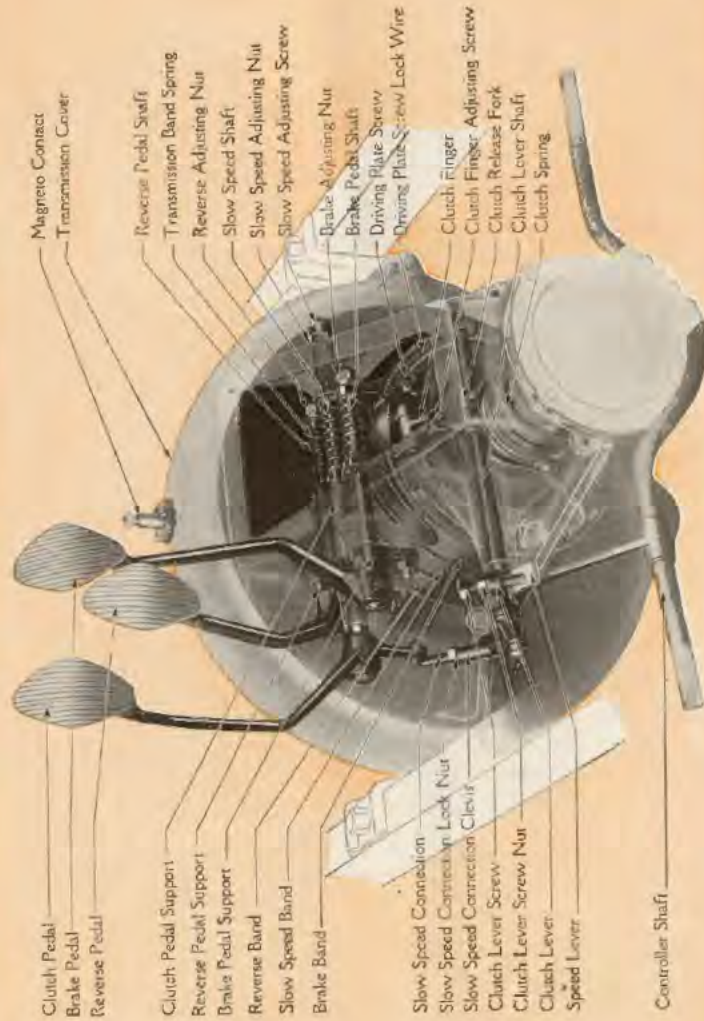

The above drawing of Transmission shows clearly the operation of Clutch, Reverse and Brake Pedals. (Cut No. 14)

How is the Clutch adjusted?

Answer No. 73

Remove the plate on the transmission cover under the floor boards at the driver's feet. Take out the cotter key on the first clutch finger and give the set screw one-half to one complete turn to the right with a screw-driver. Do the same to the other finger set screws. But be sure to give each the same number of turns and don't forget to replace the cotter key. And after a considerable period of service the wear in the clutch may be taken up by installing another pair of clutch discs, rather than by turning the adjusting screws in too far.

CAUTION: Let us warn you against placing any small tools or objects over or in the transmission case without a good wire or cord attached to them. It is almost impossible to recover them without taking off the transmission cover.

How are the Bands adjusted?

Answer No. 74

The slow speed band may be tightened by loosening the lock nut at the right side of the transmission cover, and turning the adjusting screw (see Cut No. 14) to the right. To tighten the brake and reverse bands remove the transmission case cover door and turn the adjusting nuts on the shafts to the right. See that the bands do not drag on the drums when disengaged, as they exert a brake effect, and tend to overheat the motor. However, the foot brake should be adjusted so that a sudden pressure will stop the car immediately, or slide the rear wheels in case of emergency. The bands, when worn to such an extent that they will not take hold properly, should be relined, so that they will engage smoothly without causing a jerky movement of the car. The lining is inexpensive and may be had at any of the eight thousand Ford service stations at small cost.

How are the Bands removed?

Answer No. 75

Take off the door on top of transmission cover. Turn the reverse adjustment nut and the brake adjustment nut to the extreme end of the pedal shafts, then remove the slow speed adjusting screw. Remove the bolts holding the transmission cover to crank case and lift off the cover assembly. Slip the band nearest the flywheel over the first of the triple gears, then turn the band around so that the opening is downward. The band can now be removed by lifting upward. The operation is more easily accomplished if the three sets of triple gears are so placed that one set is about ten degrees to the right of center at top. Each band is removed by the same operation. It is necessary to shove each band forward on to the triple gears as at this point only is there sufficient clearance in the crank case to allow the ears of the transmission bands to be turned downward. By reversing this operation the bands may be installed. After being placed in their upright position on the drums pass a cord around the ears of the three bands, holding them in the center so that when putting the transmission cover in place no trouble will be experienced in getting the pedal shafts to rest in the notches in the band ears. The clutch release ring must be placed in the rear groove of the clutch shaft. With the cover in place remove the cord which held the bands in place while the cover was being installed.

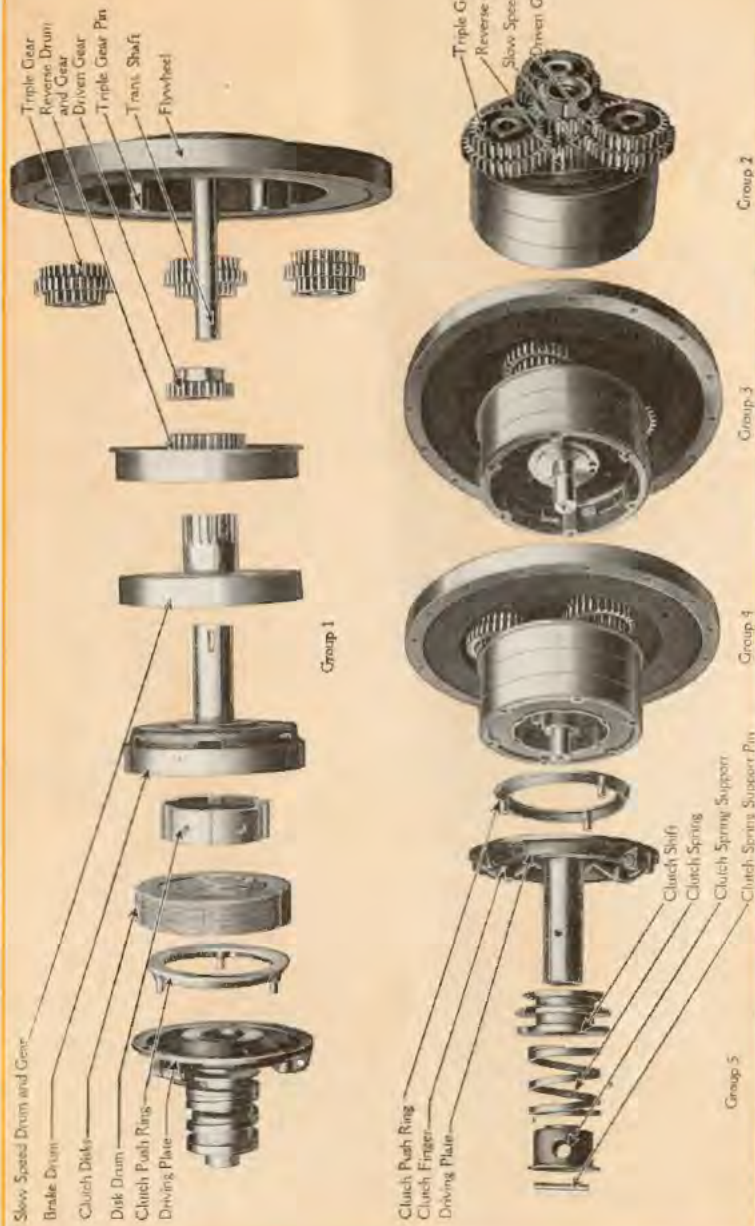

Transmission parts in their relative assembling positions. (Cut No. 15)

How is the Transmission assembled?

Answer No. 76

Cut No. 15 shows the transmission parts in their relative assembling positions and grouped in their different operations of assembling.

The first operation is the assembling of group No. 2, which is as follows: Place the brake drum on table with the hub in a vertical position, place the slow speed plate over the hub with gear uppermost. Then place reverse plate over the slow speed plate so that the reverse gear surrounds the slow speed gear. Fit the two keys in the hub just above the slow speed gear. Put the driven gear in position with the teeth downward so that they will come next to the slow speed gear. Take the three triple gears and mesh them with the driven gear according to the punch marks on the teeth, the reverse gear or smallest of the triple gear assembly being downward. After making sure that the triple gears are properly meshed tie them in place by passing a cord around the outside of the three gears. Take the flywheel and place it on the table with the face downward and the transmission shaft in a vertical position; then invert the group which you have assembled over the transmission shaft, setting it in position so that the triple gear pins on the flywheel will pass through the triple gears. This will bring the brake drum on top in a position to hold the clutch plates, etc. The next step is to fit the clutch drum key in the transmission shaft. Press the clutch disc drum over the shaft and put the set screw in place to hold the drum. Put large disc over the clutch drum, then a small disc, alternating with large and small discs until the entire set of discs are in position, ending up with a large disc on top.

If a small disc is on top it is liable to fall over the clutch drum in changing the speed from high to low and as a result you would be unable to change the speed back into high. Next put the clutch push ring over the clutch drum, and on top of the discs, with the three pins projecting upward (see Group No. 4, Cut No. 15). You will note the remaining parts are placed as they will be assembled. Next bolt the driving plate in position so that the adjusting screws of the clutch fingers will bear against the clutch push ring pins. Before proceeding further it would be a good plan to test the transmission by moving the plates with the hands. If the transmission is properly assembled the flywheel will revolve freely while holding any of the drums stationary. The clutch parts may be assembled on the driving plate hub as follows: Slip the clutch shift over the hub so that the small end rests on the ends of the clutch fingers. Next put on the clutch spring, placing the clutch supports inside so that the flange will rest on the upper coil of the spring and press into place, inserting the pin in the driving plate hub through the holes in the side of the spring support. Then turn the clutch spring support until the pin fits into the lugs on the bottom of the support. The easiest method of compressing the spring sufficiently to insert the pin is to loosen the tension of the clutch finger by means of the adjusting screws. When tightening up the clutch again the spring should be compressed to within a space of two or two and one-sixteenth inches to insure against the clutch spring slipping. Care should be exercised to see that the screws in the fingers are adjusted so the spring is compressed evenly all around.

How is Rear Axle Shaft removed?

Answer No. 82

Disconnect rear axle as directed in Answer No. 77, then unbolt the drive shaft assembly where it joins the rear axle housing at the differential. Disconnect the two radius rods at the outer ends of the housing. Take out the bolts which hold the two halves of the rear axle housing together at the center. Take the inner differential casing apart and draw the axle shaft through the housing at the center.

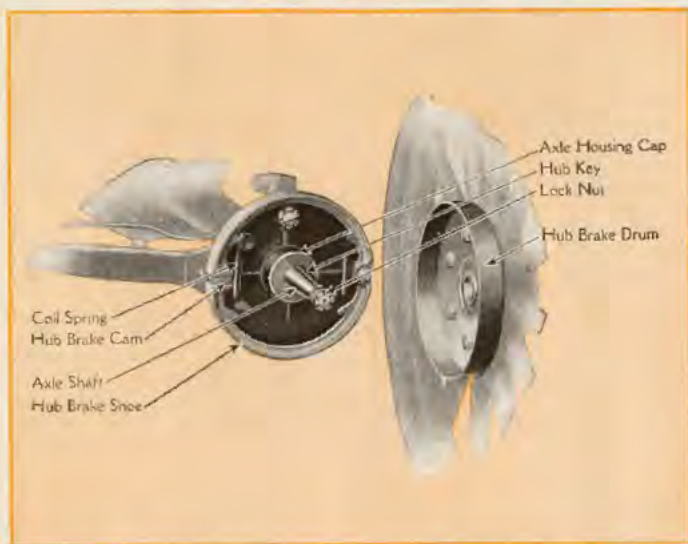

The Ford Emergency Brake. (Cut No. 17)

After replacing the axle shaft be sure that the rear wheels are firmly wedged on at the outer end of the axle shaft and the key in proper position. When the car has been driven thirty days or so, make it a point to remove the hub cap and set up the lock nut to overcome any play that might have developed. It is extremely important that the rear wheels are kept tight, otherwise the constant rocking back and forth against the keyway may in time cause serious trouble.

If the rear axle or wheel is sprung by skidding against a curb, or other accident, it is false economy to drive the car, as tires, gears and all other parts will suffer. If the axle shaft is bent, it can, with proper facilities, be straightened, but it is best to replace it.

The Ford Muffler

Why is the Muffler necessary?

Answer No. 83

The exhaust as it comes from the engine through the exhaust pipe would create a constant and distracting noise were it not for the muffler. From the comparatively small pipe, the exhaust is liberated into the larger chambers of the muffler, where the force of the exhaust is lessened by expansion and discharged out of the muffler with practically no noise. (See Cut No. 18.) The Ford muffler construction is such that there is very little back pressure of the escaping gases, consequently there is nothing to be gained by putting a cut-out in the exhaust pipe between the engine and the muffler.

How is the Muffler kept in order?

Answer No. 84

It should be cleaned occasionally. Remove it (see Answer No. 85) and take off nuts on ends of rods which hold it together—and disassemble.

In reassembling muffler, be careful not to get the holes in the inner shells on the same side or end.

How is the Muffler disconnected?

Answer No. 85

To disconnect the muffler it is not necessary to disconnect the exhaust pipe from the motor (although it is a good plan and a simple matter, necessitating only unscrewing the union). To disconnect muffler from frame, unscrew union at forward end of pipe, drop it down so it will clear the frame and slip it back off the tube. If the muffler from any cause becomes materially damaged it will probably be cheaper to replace it with a new one than to attempt to repair it.



The Ford Muffler. (Cut No. 18)

The Running Gear

What care should the Running Gear have?

Answer No. 86

In the first place it at all times should have proper lubrication (see chapter on Lubrication). Once in every thirty days the front and rear axles should be carefully gone over to see that every moving part, such as the bushings in spring connections, spring hangers, steering knuckles and hub bearings, are thoroughly lubricated, and that all nuts and connections are secured with cotter pins in place. The spring clips, which attach the front spring to the frame, should be inspected frequently to see that everything is in perfect order.

How is the Front Axle removed?

Answer No. 87

Jack up front of car so wheels can be removed (see Answer No. 90), disconnect steering gear ball arm from the spindle connecting rod, disconnect radius rod at ball joint, and remove two cotter pin bolts from spring shackle on each side, so detaching front spring. To disconnect radius rod from axle, remove cotter-pinned nuts. To remove radius rod entirely, take the two bolts out of the ball joint and remove lower half of cap.

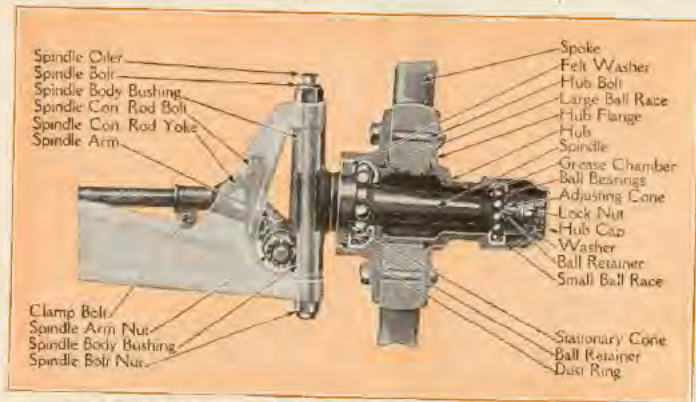

The Ford Spindle and Front Hub Assembly. (Cut No. 19)

In case of accident, how is the Front Axle straightened?

Answer No. 88

Should the axle or spindle become bent extreme care must be used to straighten the parts accurately. Do not heat the forgings, as this will distemper the steel, but straighten them cold. If convenient it would be better to return such parts to the factory, where they may be properly straightened in jigs designed for that purpose. It is very essential that the wheels line up properly (see Answer No. 91).

[42]

The eye is not sufficiently accurate to determine whether the parts have been properly straightened, and excessive wear of the front tires will occur if everything is not in perfect alignment.

What about the Wheels?

Answer No. 89

The wheels should be jacked up periodically and tested, not only for smoothness of running, but for side play as well. If in spinning a front wheel a sharp click occurs now and then and the wheel is momentarily checked, it is probable that there is a chipped or split ball in the bearing which should be removed, otherwise it may necessitate the removal of the entire bearing. A wheel in perfect adjustment should, after spinning, come to rest with the tire valve directly below the hub. Undue wear of the hub bearings, such as cones, balls and races, is usually caused by lack of lubrication and excessive friction, due to the adjusting cone being screwed up too tight. It is a good plan to clean the bearings frequently and keep the hub well filled with grease.

How are the Wheels removed?

Answer No. 90

Front wheels: Take off hub cap, remove cotter pin and unscrew castle nut and spindle washer. The adjustable bearing cone can then be taken out and the wheel removed. Care should be taken to see that the cones and lock nuts are replaced on the same spindle from which they were removed, otherwise there is a liability of stripping the threads which are left on the left spindle and right on the opposite as you stand facing the car. Back wheels: They should not be removed unless absolutely necessary—in which case proceed as above, then with a wheel puller remove the wheel from the tapered shaft to which it is locked with a key. In replacing rear wheels be sure that nut on axle shaft is as tight as possible and cotter pin in place. The hub caps of the rear wheels should be removed occasionally and the lock nuts which hold the hub in place tightened up. If these nuts are allowed to work loose, the resulting play on the hub key may eventually twist off the axle shaft.

How does the setting of the Front Wheels differ from that of the Rear Wheels?

Answer No. 91

It will be observed that the front wheels are "dished"; that is, the spokes are given a slight outward flare to enable them to meet side stresses with less rigid resistance—while the spokes of the rear wheels are straight. The front wheels are also placed at an angle—that is to say, the distance between the tops of the front wheels is about three inches greater than between the bottoms. This is to give perfect steering qualities and to save wear on the tires when turning corners. The front wheels should not, however, "toe-in" at the front—at least not more than a quarter of an inch. Lines drawn along the outside of the wheels when the latter are straight in a forward position should be parallel. All wheels should always be kept in proper alignment, otherwise steering will be difficult and tire wear greatly increased. Adjustment can be made by turning the yoke at the left end of the spindle connecting rod, to draw the wheels into a parallel position.

What care do the Springs need?*Answer No. 92*

The springs should be lubricated frequently with oil or graphite. To do this, pry the leaves apart near the ends and insert the lubricant between them. Whenever a car is given a general overhauling, the springs should be disassembled and the leaves polished with emery cloth, afterwards packing them with graphite when reassembling. Rust can be prevented from accumulating on the springs by painting them when necessary with a quick drying black paint. You will find that these suggestions if carried out will not only improve the riding qualities of the car but prolong the life of the parts as well.

Should Spring Clips be kept tight?*Answer No. 93*

Yes. If the spring clips are allowed to work loose the entire strain is put on the tie bolt which extends through the center of the spring. This may cause the bolt to be sheared off and allow the frame and body to shift a trifle to one side. It is a good plan to frequently inspect the clips which hold the springs to the frame and see that they are kept tight.

What about the Steering Apparatus?*Answer No. 94*

It is exceedingly simple and will need little care—except, of course, proper lubrication. The post gears which are arranged in the "sun and planet" form are located at the top of the post just below the hub of the wheel (see Cut No. 1). By loosening the set screw and unscrewing the cap—after having removed the steering wheel—they may readily be inspected and replenished with grease. To remove the steering wheel, unscrew the nut on top of the post and drive the wheel off the shaft with a block of wood and hammer.

How is Steering Gear tightened?*Answer No. 95*

Should the steering gear become loose, that is, so that a slight movement of the wheel does not produce immediate results, it may be tightened in the following manner: Disconnect the two halves of the ball sockets which surround the ball arm at the lower end of the steering post and file off the surface until they fit snugly around the ball. If the ball is badly worn it is best to replace it with a new one. Also tighten the ball caps at the other end of the steering gear connecting rod in the same manner. If the bolts in the steering spindle arms appear to be loose, the brass bushings should be replaced with new ones (see Cut No. 19). Excessive play in the front axle may be detected by grasping one of the front wheels by the spokes and jerking the front axle back and forth. After the car has been in service two or three years excessive play in the steering gear may make necessary the renewal of the little pinions, as well as the brass internal gear just underneath the steering wheel spider.

It is also advisable to inspect the front spring hangers occasionally to determine whether or not new bushings are necessary to overcome any excessive vibration.

The Ford Lubricating System**How does the Ford Lubricating System differ from others?***Answer No. 96*

It is simplified—and there are fewer places to oil. Practically all of the parts of the engine and transmission are oiled by the Ford splash system, from the one big oil reservoir in the crank case. Cut No. 20 shows the principal points of lubrication, and specifies when replenishment should be made, according to mileage. This chart should be studied carefully and often. It is a good plan to frequently supply all oil cups with the same oil used in the engine (any good light grade lubricating oil will answer) and the dope cups with good grease. Be sure to see that the commutator is kept freely supplied with oil at all times.

Which is the best way to fill the "Dope" Cups?*Answer No. 97*

When it is advisable to fill dope cup covers screw them down, refill with grease and repeat the operation two or three times. Always open oil cups by turning to right, as this keeps tightening rather than loosening them. Occasionally remove front wheels and supply dope to wearing surface. A drop of oil now and then in crank-handle bearing is necessary, also on fan belt pulleys and shaft. The axles, drive shaft and universal joint are well supplied with lubricant when the car leaves the factory, but it is well to examine and oil them frequently.

What kind of oil should be used?*Answer No. 98*

We recommend only light high grade gas engine oil for use in the Model T motor. A light grade of oil is preferred as it will naturally reach the bearings with greater ease and consequently less heat will develop on account of friction. The oil should, however, have sufficient body so that the pressure between the two bearing surfaces will not force the oil out and allow the metal to come in actual contact. Heavy and inferior oils have a tendency to carbonize quickly, also "gum up" the piston rings, valve stems and bearings. In cold weather a light grade of oil having a low cold test is absolutely essential for the proper lubrication of the car. The nearest Ford Branch will advise you concerning the lubricating oil this Company has found best suited for its cars, both for summer and winter weather. Graphite should not be used as a lubricant in the engine or transmission as it will have a tendency to short-circuit the magneto.

How often should Oil be drained from Crank Case?

Answer No. 99

It is advisable to clean out the crank case by draining off the dirty oil when the new car has been driven four or five hundred miles; thereafter it will only be necessary to repeat this operation about every thousand miles. Remove plug underneath the flywheel casing and drain off the oil. Replace the plug and pour in a gallon of kerosene oil through the breather pipe. Turn the engine over by hand fifteen or twenty times so that the splash from the kerosene oil will thoroughly cleanse the engine. Remove crank case plug and drain off kerosene oil. In order to get all the kerosene out of the depressions in the crank case the car should be run up a little incline, about the height of the ordinary street curbing. Refill with fresh oil.

How often should Commutator be oiled?

Answer No. 100

Keeping the commutator well oiled is a matter of far greater importance than many drivers believe, and is necessary in order to have a smooth operating engine. Don't be afraid to put a little oil into the

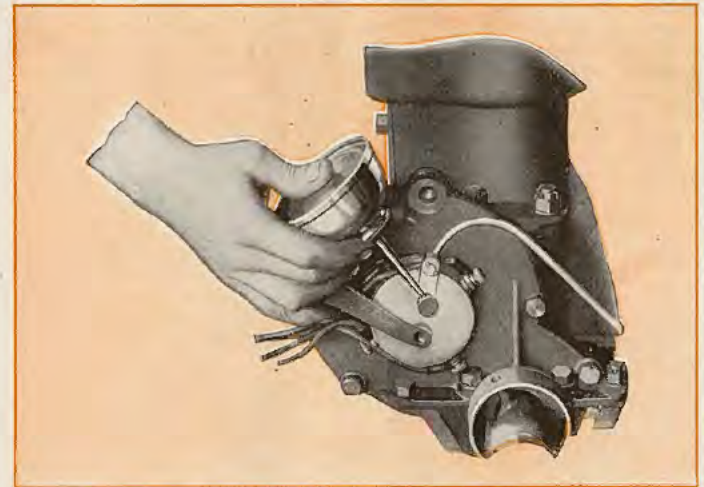
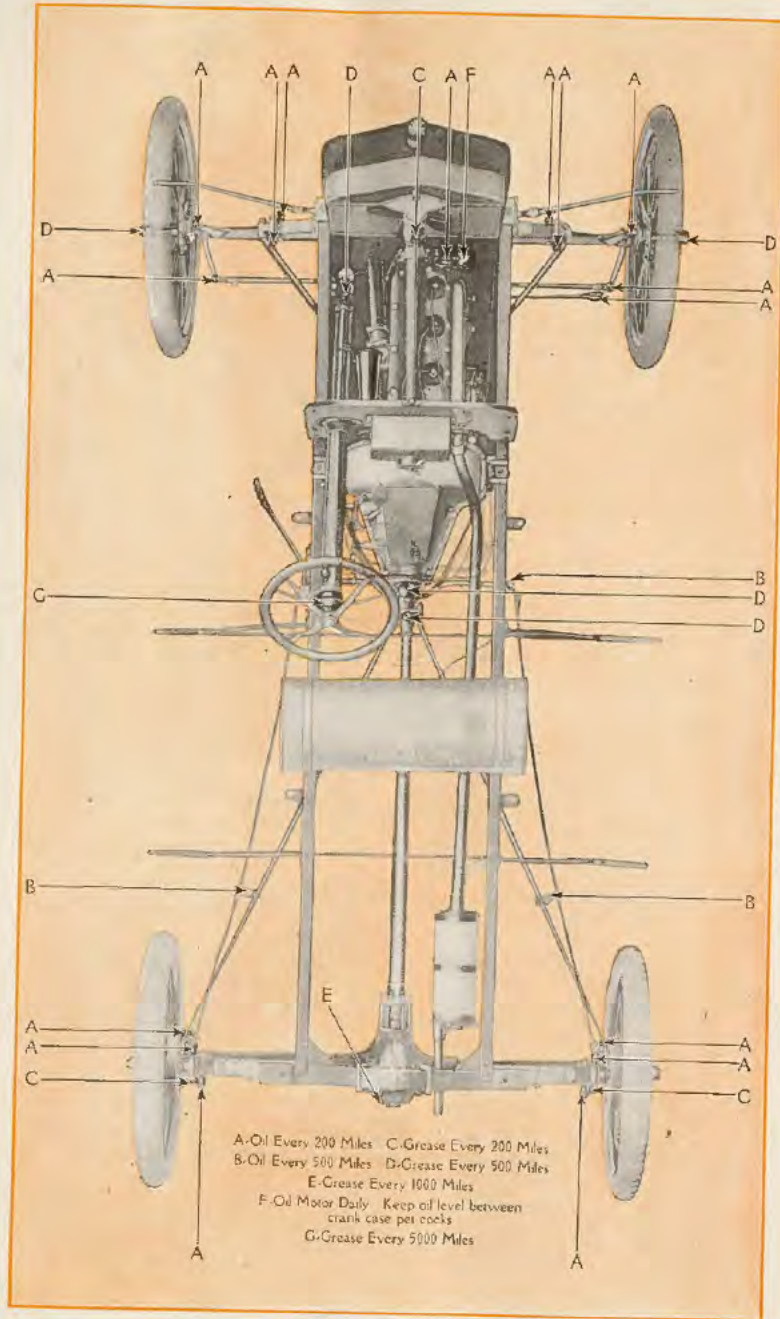

Oiling the Ford Commutator. (Cut No. 21)

commutator every other day—at least every 200 miles. Remember that the commutator roller revolves very rapidly, and without sufficient lubrication the parts soon become badly worn. When in this condition perfect contact between the roller and the four contact points is impossible, as a result the engine is apt to misfire when running at a good rate of speed.

What About Lubricating the Differential?*Answer No. 101*

Do not make the mistake of putting too much grease in the differential housing. The housing should not be more than one-third full. The differential is supplied with the required amount of lubricant when the car leaves the factory. The oil plug should be removed about every 1000 miles and more grease added if necessary. If a fluid grease is used the level should be approximately one and one-half inches below the oil hole.

Care of the Tires**How are Ford Tires removed?***Answer No. 102*

First, jack up the wheel clear of the road. The valve cap should be unscrewed, the lock nut removed and the valve stem pushed into the tire until its bead is flush with the rim. This done, loosen up the head of the shoe in the clinch of the rim by working and pushing with the hands, then insert one of the tire irons or levers under the beads. The tire iron should be pushed in just enough to get a good hold on the under side of the bead, but not so far as to "pinch" the inner tube between the rim and the tool. A second iron should be inserted in the same fashion some seven or eight inches from the first, and a third tool the same distance from the second. As a clincher tire must be pried over the clinch, three or four levers will come in handy in a case of a "one-man job," and the knee of the driver can be used to good advantage to hold down one lever while the other two are being manipulated in working the shoe clear of the rim. After freeing a length of the bead from the clinch, the entire outer edge of the casing may be readily detached with the hands, and the damaged inner tube removed and "patched" or a spare tube inserted. Always use plenty of soapstone in replacing an inner tube.

How are Casings repaired?*Answer No. 103*

Should the casing be cut so there is danger of the inner tube being blown through it, a temporary repair can be made by cementing a canvas patch on the inside of the casing. Before applying the patch the part of the casing affected should be cleaned with gasoline and when dry, rubber cement applied to both casing and patch. This will answer as an emergency repair—but the casing should be vulcanized at the first opportunity.

To prolong the life of the tire casings, any small cuts in the tread should be filled with patching cement and a specially prepared "plastic" sold by the tire companies.

How may Tire Expense be reduced?*Answer No. 104*

Tire cost constitutes one of the most important items in the running expenses of an automobile. To get the most service at the least

expense, the tires should be inspected frequently and all small cuts or holes properly sealed or repaired—thus preventing dirt and water working in between the rubber tread and the fabric, causing blisters or sand boils.

Tires should never be run partially deflated, as the side walls are unduly bent and the fabric is subject to stresses which cause what is known as rim cutting. The chances of getting a puncture will be greatly reduced by keeping your tires properly inflated, as a hard tire exposes much less surface to the road than a soft tire, and also deflects sharp objects that would penetrate a soft tire.

Running a tire flat, even for a short distance, is sure to be costly. Better run on the rim, very slowly and carefully, rather than on a flat tire.

Remember that fast driving and skidding shorten the life of the tires. Avoid locking the wheels with the brakes—no tire will stand the strain of being dragged over the pavement in this fashion.

Avoid running in street car tracks, in ruts, or bumping the side of the tire against the curbing.

The wheel rims should be painted each season and kept free from rust.

When a car is idle for any appreciable length of time, it should be jacked up to take the load off the tires. If the car is laid up for many months, it is best to remove the tires, and wrap up the outer casings and inner tubes separately, and store them in a dark room not exposed to extreme temperatures. Remove oil or grease from the tires with gasoline. Remember that heat, light and oil are three natural enemies of rubber.

How is a puncture in the Inner Tube repaired?*Answer No. 105*

After locating the puncture, carefully clean the rubber around the leak with benzine or gasoline. Then rough the surface with sandpaper from your tire repair kit to give a hold for the cement. Apply the cement to both patch and tube, allowing it to dry for about five minutes, repeating the application twice with like intervals between for drying. When the cement is dry and sticky press the patch against the tube firmly and thoroughly to remove all air bubbles beneath it and insure proper adherence to the surface—then spread some soapstone or talc powder over the repair so as to prevent the tube sticking to the casing. Before the tube is put back into the casing plenty of talc powder should be sprinkled into the latter. A cement patch is not usually permanent and the tube should be vulcanized as soon as possible. In replacing the tire on the rim be very careful not to pinch the tube.

Points on Maintenance

What is the proper way to wash the Car?

Answer No. 106

Always use cold or lukewarm water—never hot water. If a hose is used, don't turn on the water at full force, as this drives the dirt into the varnish and injures the finish. After the surplus mud and grime have been washed off, take a sponge and clean the body and running gear with a tepid solution of water and ivory or linseed oil soap. Then rinse off with cold water; then rub dry and polish the body with a chamouis skin. A body or furniture polish of good quality may be used to add lustre to the car. Grease on the running gear may be removed with a gasoline-soaked sponge or rag. The nicked parts may be polished with any good metal polish.

What care does Top need?

Answer No. 107

When putting the top down be careful in folding to see that the fabric is not pinched between the bow spacers, as they will chafe a hole through the top very quickly. Always slip the hood over the top when folded to keep out dust and dirt. Applying a good top dressing will greatly improve the appearance of an old top.

What should be done when the Car is stored?

Answer No. 108

Drain the water from the radiator, and then put in about a quart of denatured alcohol to prevent freezing of any water that may possibly remain. Remove cylinder head and clean out any carbon deposits in combustion chamber. Draw off all the gasoline. Drain the dirty oil from the crank case and cleanse the engine with kerosene as directed in Answer No. 99. Refill the crank case with fresh oil and revolve the engine enough to cover the different parts with oil. Remove the tires and store them away. Wash up the car, and if possible cover the body with a sheet of muslin to protect the finish.

What attention do the Electric Head Lights require?

Answer No. 109

Very little. When the cars leave our factory the lamps are properly focused and unless the bulb burns out there should be no occasion for removing the door, as there is nothing to get out of order. Should the door be removed for any reason care should be exercised not to touch the silver-plated reflector or the bulb with anything but a soft, clean rag, preferably flannel. To focus the lamps turn the adjusting screw in the back of lamp in either direction until the desired focus is attained. The bulbs we are furnishing in electric head lamps are 8 volts, 2 amperes, and best results will be obtained by securing lamps of this voltage and amperage when replacement is necessary.

The Ford Model T One Ton Truck

Do the Instructions relative to the Car apply to the Truck?

Answer No. 110

The answers pertaining to the car are applicable to the truck, with the exception of Nos. 77 to 82 inclusive.

How is the Rear Axle removed?

Answer No. 111

Jack up the truck, place supports under rear axle housings, and remove the rear wheels. Take out the four bolts connecting the universal ball cap to the transmission case and cover. Disconnect brake rods. Remove nuts holding spring perches to rear axle housing flanges. Raise frame by placing a long iron bar or gas pipe under the frame just in front of rear spring, one end resting on a substantial support of the proper height. Two workmen at the other end of the bar can raise the frame and place the end of the bar on another support. The rear axle assembly can then be easily withdrawn.

How is the Universal Joint disconnected from the Drive Shaft?

Answer No. 112

Remove two plugs from top and bottom of ball casting and turn shaft until pin comes opposite hole, drive out pin and the joint can be pulled or forced away from the shaft and out of the housing.

How are the Rear Axle and Differential disassembled?

Answer No. 113

With the universal joint disconnected, remove the bolt in front end of radius rods and the cap screws which hold the drive shaft tube to the rear axle housing. Then remove the rear axle housing cap; also the bolts which hold the two halves of the differential housing together. With the differential exposed to view, the manner of disassembling it will be apparent. Care must be exercised to get every part back in its correct position when reassembling, being sure to use new paper liners.

How is the Worm removed?

Answer No. 114

To remove the worm, drive out the pins which hold the coupling to the worm and drive shaft. Then remove the felt washer, roller bearing sleeve, and roller bearing by slipping them over the coupling. Drive the coupling off from the drive shaft and then force the worm from the coupling. Removing the worm nut will permit the removal of the retaining washer, thrust bearing and rear worm roller bearing. In reassembling be sure that the pin which holds the retaining washer stationary is in place.

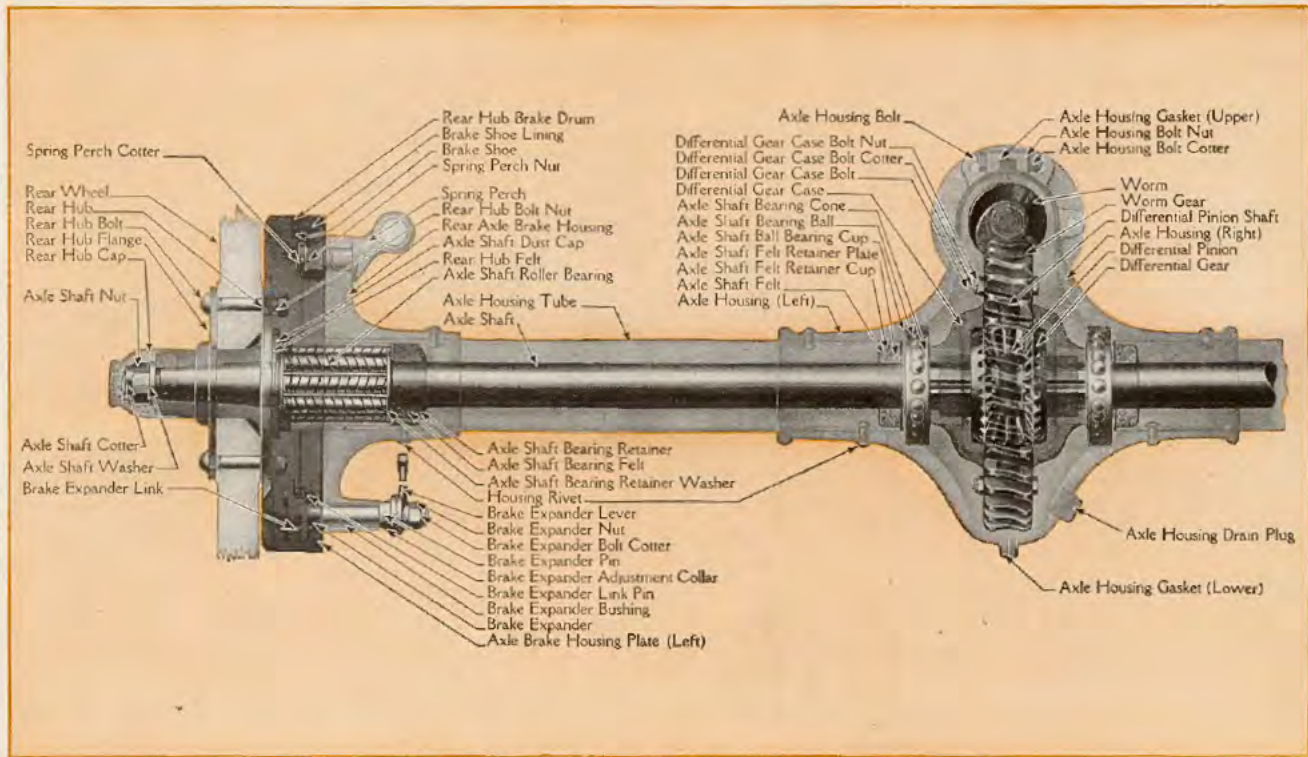

Truck Rear Axle—Longitudinal View (Cut No. 22)

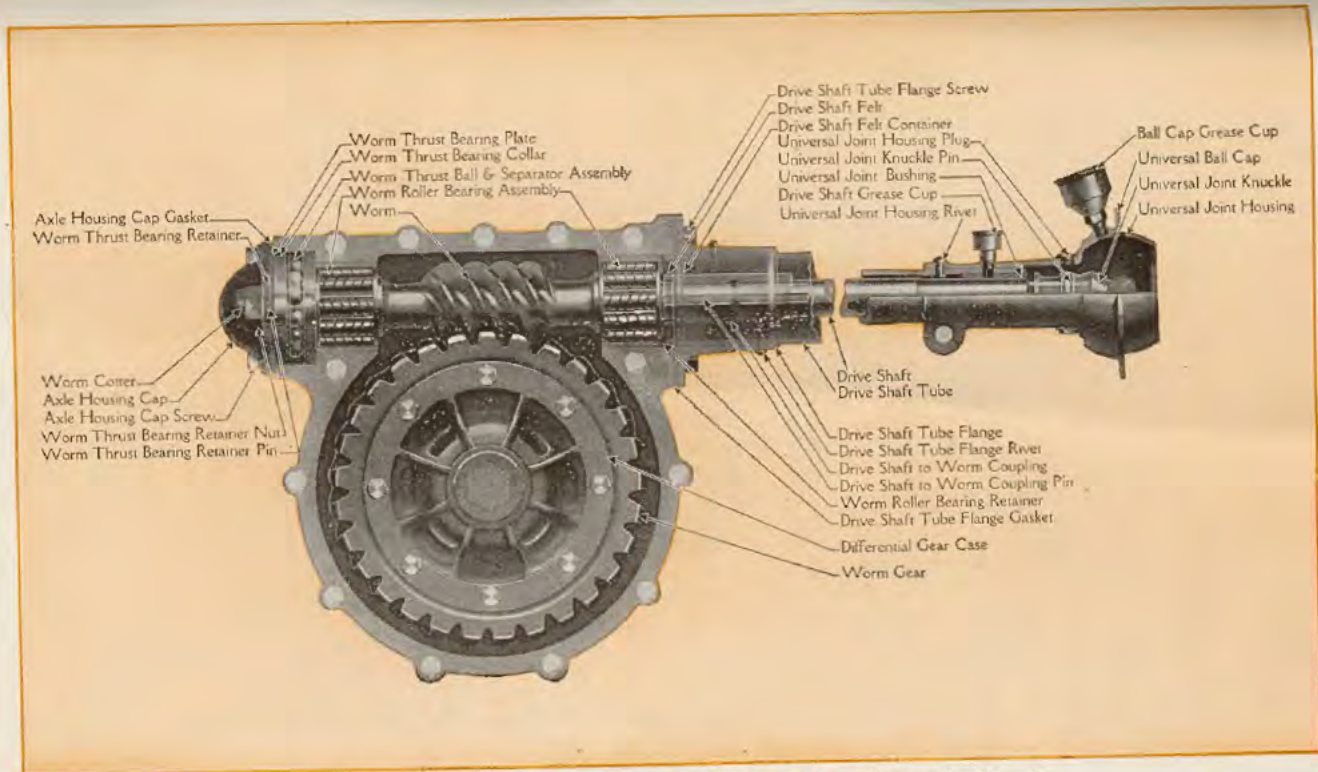

Truck Rear Axle—Cross Section showing Worm and Worm Gear (Cut No. 23)

How is the Rear Axle Shaft removed?*Answer No. 115*

Remove the rear axle assembly as directed in Answer No. 111. Disconnect brake rods and radius rods at rear axle housing flange; also remove nuts holding spring perches to flanges. Take out the cap screws holding the drive shaft tube to the rear axle housing and remove the rear axle housing cap and the bolts which hold the two halves of the differential housing together, then pull or force the housings from the shafts and disassemble differential. After replacing the axle shaft be sure that the rear wheels are firmly wedged on at the outer end of the axle shaft and the key in proper position. When the truck has been driven thirty days or so make it a point to remove the hub cap and set up the lock nut to overcome any play that might have developed. It is extremely important that the rear wheels are kept tight, otherwise the constant rocking back and forth against the key-way may in time cause serious trouble.

How is the Differential Gear removed from the Shaft?*Answer No. 116*

The differential gear is fastened to the inner end of the rear axle shaft by means of splines, and is held in position by a ring which is in two halves and fits in a groove in the rear axle shaft. To remove the gear, force it down on the shaft, that is, away from the end to which it is fastened, drive out the two halves of the ring in groove in shaft with screw-driver or chisel, and force the gear off the end of the shaft.

What about Lubricating the Rear Axle?*Answer No. 117*

Extreme care must be used in lubricating the differential. An A-1 heavy fluid or semi-fluid oil, such as Mobiloil C or Whittemore's Worm Gear Protective, should be used and carried at a level with the upper oil plug. The differential is supplied with the required amount of lubricant when the truck leaves the factory and the supply should be maintained by replenishments as required. After running the truck about 500 miles, the oil should be drained off by removing the lower oil plug, and the differential filled with fresh lubricant. This operation should be repeated at approximately 1000 miles, and after that whenever necessary. The rear axle outer roller bearings are lubricated by means of dope cups. These cups should be kept filled with a good grade of grease and given a full turn every 100 miles. Before putting the truck back in service after the rear axle has been taken down, fill the differential with oil, jack up the axle and run it for five or ten minutes to insure proper lubrication of all bearings.

The P. A. Starting and Lighting System Installed on Sedans and Coupes**Of what does the Starting and Lighting System consist?***Answer No. 118*

The starting and lighting system is of the two unit type and consists of the starting motor, generator, storage battery, charging indicator, and lights, together with the necessary wiring and connections.

Where is the Starter located?*Answer No. 119*

The starting motor is mounted on the left-hand side of the engine and bolted to the transmission cover. When in operation the pinion on the Bendix drive shaft engages with the teeth on the flywheel.

What must be done before starting the Engine?*Answer No. 120*

The spark and throttle levers should be placed in the same position on the quadrant as when cranking by hand, and the ignition switch turned on. Current from either battery or magneto may be used for ignition. When starting, especially if the engine is cold, the ignition switch should be turned to "battery." As soon as the engine is warmed up, turn switch back to "magneto." The magneto was designed to furnish ignition for the Model T engine and better results will be obtained by operating in this way. Special attention must be paid to the position of the spark lever as a too advanced spark will cause serious backfiring which in turn will bend or break the shaft in the starter. The starting motor is operated by a push button, conveniently located in the floor of the car at the driver's feet. With the spark and throttle levers in the proper position, and the ignition switch turned on, press on the push button with the foot. This closes the circuit between the battery and starting motor, causing the pinion of the Bendix drive shaft to engage with the teeth on the flywheel, thus turning over the crank shaft. When the engine is cold it may be necessary to prime it by pulling out the carburetor priming rod, which is located on the instrument board. In order to avoid flooding the engine with an over rich mixture of gas, the priming rod should only be held out for a few seconds at a time.

What if the Engine fails to start?*Answer No. 121*

If the starting motor is turning the crank shaft over and the engine fails to start, the trouble is not in the starting system. In this event, release the button at once so as not to unnecessarily discharge the battery and inspect the carburetor and ignition system to determine the trouble.

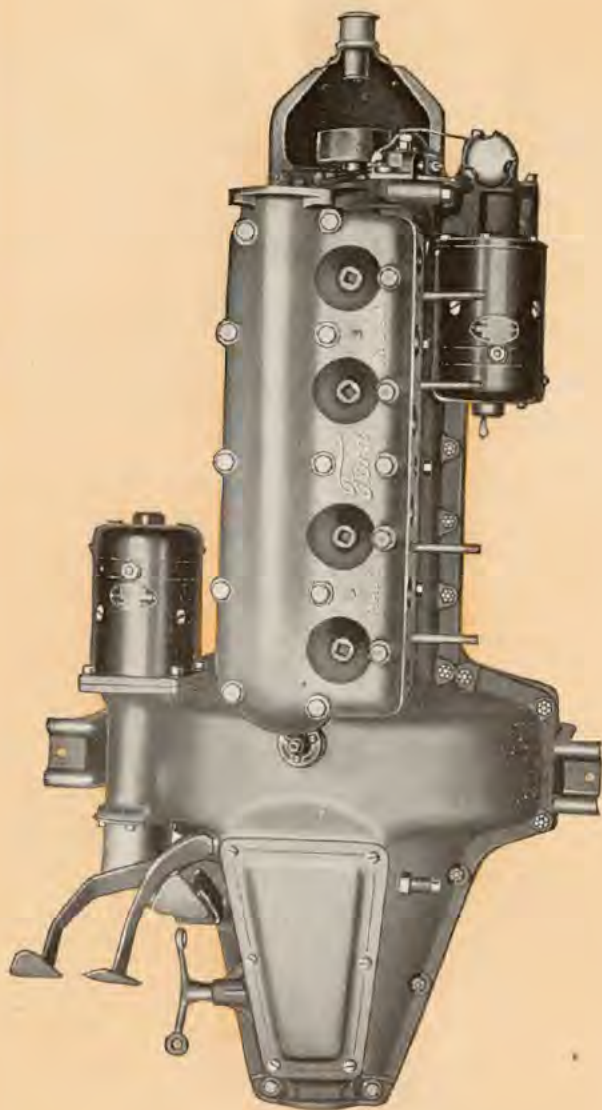

Top view of Model T Motor, showing Starter and Generator in position (Cut No. 24)

What if the Starting Motor fails to act?

Answer No. 122

If the starting motor fails to act, after pushing the button, first inspect the terminal on the starting motor, the two terminals on the battery and the two terminals on starting switch, making sure all of the connections are tight; then examine the wiring for a break in the insulation that would cause a short-circuit. If the wiring and connections are O. K. and the starting motor fails to act, test the battery with a hydrometer. If the hydrometer reading is less than 1.225 the trouble is no doubt due to a weak or discharged battery.

How is the Generator operated?

Answer No. 123

The generator is mounted on the right-hand side of the engine and bolted to the cylinder front end cover. It is operated by the pinion on the armature shaft engaging with the large time gear. The charging rate of generator is set so as to cut in at engine speeds corresponding to 10 miles per hour in high speed and reaches a maximum charging rate at 20 miles per hour. At higher speeds the charge will taper off, which is a settled characteristic of battery charging. This operation of cutting in and cutting out at suitable speeds is accomplished by the cut-out, which is mounted on the dash. This cut-out is set properly at the factory and should not under any circumstances be tampered with.

What about Oiling?

Answer No. 124

The starting motor is lubricated by the Ford splash system, the same as the engine and transmission. The generator is lubricated by a splash of oil from the time gears. In addition an oil cup is located at the end of the generator housing and a few drops of oil should be applied occasionally.

What should be done when repairing the Ignition?

Answer No. 125

The introduction of a battery current into the magnets will discharge the magnets and whenever repairing the ignition system or tampering with the wiring in any way, do not fail to disconnect the positive wire from the battery. The end of this wire should be wound with tape to prevent its coming in contact with the ignition system or metal parts of the car.

How does the Charging Indicator operate?

Answer No. 126

The charging indicator is located on the instrument board. This indicator registers "charge" when the generator is charging the battery and "discharge" when the lights are burning and the engine not running above 10 miles per hour. At an engine speed of 15 miles per hour or more the indicator should show a reading of from 10 to 12, even with the lights burning. If the engine is running above 15 miles per hour and the indicator does not show "charge," first inspect the terminal posts on the indicator, making sure that the connections are

engine pan. Extreme care should be used in removing the Bendix drive and other parts that none are misplaced nor lost and that they are replaced in their former position. In replacing the starter, be sure that the terminal connection is placed at the top. If the car is to be operated with the starter removed, be sure to put the transmission cover plates in position. These plates may also be obtained from the nearest branch.

How is the Generator removed?

Answer No. 130

If it is found necessary to remove the generator, first take out the three cap screws holding it to the front end cover and by placing the point of a screw-driver between the generator and front end cover, the generator may be forced off the engine assembly. Always start at the top of the generator and force it backward and downward at the same time. Plates may be obtained from the nearest branch to place over the time gear if the car is to be operated with the generator removed.

Can the Engine be run with the Generator disconnected from the battery?

Answer No. 131

If for any reason the engine is run with the generator disconnected from the battery, as on a block test, or when battery has been removed for repair or recharging, be sure that the generator is grounded to engine by running a wire from the terminal on generator to one of the valve cover stud nuts. A piece of wire $\frac{1}{16}$ " or more in diameter may be used for this purpose. Be sure that the connections at both ends of the wire are tight. Failure to do this when running the engine with the generator disconnected from the battery will result in serious injury to the generator.

What about the care of the Battery, repairing or recharging?

Answer No. 132

The Ford Starting System uses a 6-volt 13-plate "Exide" battery, type 3-XC-13-1. The care of the battery in service is summed up in the following rules:

1. Add nothing but pure water to the cells and do it often enough to keep the plates covered at all times. Distilled water, melted artificial ice or rain water collected in clean receptacles is recommended. In cold weather add water only just before running the engine so that the charging may mix the water and the electrolyte and freezing of the water be avoided.
2. Take frequent hydrometer readings to make sure that the generator is keeping the battery charged. To take reading, remove filler cap of cell, insert end of hydrometer syringe in filler opening, squeeze bulb, and release, drawing up enough liquid to float hydrometer bulb free in the liquid. The reading of the scale at the surface of the liquid when hydrometer is floating is the specific gravity (density) of the electrolyte. A fully charged battery will show a reading of 1.275 to 1.300. A battery half charged will show a reading of 1.225 to

Starter and Generator Units (Cut No. 26)

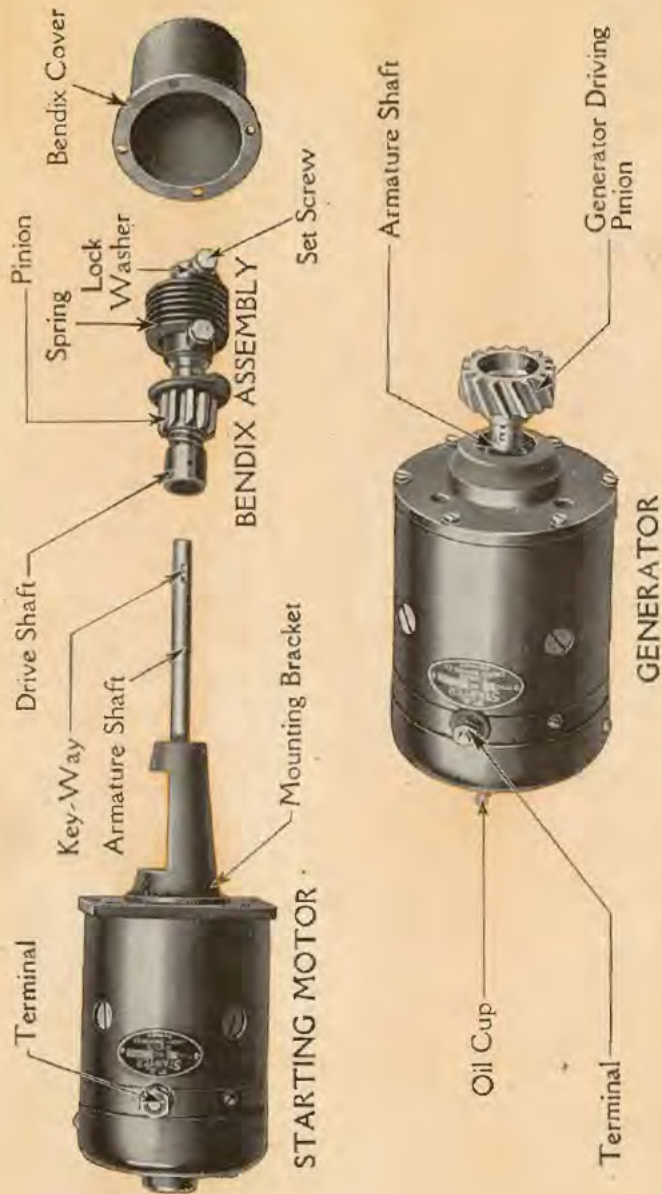

1.250. A completely discharged battery will show a reading of 1.200 or less. When taking hydrometer readings remove the filler cap from only one cell at a time and be sure to return electrolyte to the cell from which it was taken. Then replace and tighten the filler cap. Hydrometer tests taken immediately after filling with water and before water has become thoroughly mixed with the electrolyte will not show the true condition of the battery.

3. If hydrometer reading shows battery less than half charged it should be taken to the nearest Exide Battery Service Station for recharging. Continued operation in a less than half charged condition is injurious to the battery, somewhat as running in a soft or deflated condition is injurious to a tire.

4. Keep the filler caps in place and screwed tight—a half turn tightens them. Keep battery connections tight and clean. A coating of heavy oil or vaseline will protect the connectors from corrosion. Keep battery firmly secured in place. If hold-downs are loose battery will shift about in compartment and result in loose connections, broken cells or other trouble.

5. Exide Battery Service Stations are maintained in principal cities and towns throughout the country to assist you to obtain good service from your battery. Do not entrust your battery to the care of a novice.

What about Battery Guarantee?

Answer No. 133

The "Exide" batteries are guaranteed by the manufacturers (The Electric Storage Battery Company, Philadelphia, Pa.) to be free from defects in material and workmanship.

At any time within three months from date of delivery to the purchaser any battery which may prove to be defective or incapable, when fully charged, of giving its rated capacity, will be repaired or replaced free of expense on receipt, transportation charges prepaid, at any Exide Battery Depot or authorized Exide Battery Service Station. This guarantee does not cover the free charging of batteries nor the making good of damage resulting from continued lack of charge or from failure to keep the plates covered with solution by filling the cells from time to time with pure water. No claims on account of alleged defects can be allowed unless made within three months of date of delivery of battery to purchaser, and the right is reserved to refuse to consider claims in the case of batteries opened by other than authorized Exide Battery Service Stations.

Purchasers of cars equipped with "Exide" batteries are earnestly urged to cooperate with the battery manufacturers by taking their cars, as promptly as possible after receipt, to the nearest Exide Battery Service Station in order that the battery may be tested and its condition and installation checked. No charge is made for this inspection.

Summary of Engine Troubles and Their Causes

ENGINE FAILS TO START

1. Gas mixture too lean.
2. Water in gasoline.
3. Vibrators adjusted too close.
4. Water or congealed oil in commutator.
5. Magneto contact point (in trans. cover) obstructed with foreign matter.
6. Gasoline supply shut off.
7. Carburetor frozen (in zero weather).
8. Water frozen in gasoline tank sediment bulb.
9. Coil switch off.

ENGINE LACKS POWER—RUNS IRREGULARLY

At Low Speeds.

1. Poor compression—account leaky valves.
2. Gas mixture too rich or too lean.
3. Spark plugs dirty.
4. Coil vibrator improperly adjusted.
5. Air leak in intake manifold.
6. Weak exhaust valve spring.
7. Too great clearance between valve stem and push rod.
8. Too close gap between spark plug points.

At High Speeds.

1. Commutator contact imperfect.
2. Weak valve spring.
3. Too much gap in spark plug.
4. Imperfect gas mixture.
5. Vibrator points dirty or burned.

ENGINE STOPS SUDDENLY

1. Gasoline tank empty.
2. Water in gasoline.
3. Flooded carburetor.
4. Dirt in carburetor or feed pipe.
5. Magneto wire loose at either terminal.
6. Magneto contact point obstructed.
7. Overheated—account lack of oil or water.
8. Gas mixture too lean.

ENGINE OVERHEATS

1. Lack of water.
2. Lack of oil.
3. Fan belt torn, loose or slipping.
4. Carbon deposit in combustion chamber.
5. Spark retarded too far.
6. Gas mixture too rich.
7. Water circulation retarded by sediment in radiator.
8. Dirty spark plugs.

ENGINE KNOCKS

1. Carbon deposit on piston heads.
2. Loose connecting rod bearing.
3. Loose crank shaft bearing.
4. Spark advanced too far.
5. Engine overheated.



Index

Care of Tires	Page	Maintenance	Page
Care of Inner Tubes	48	Care of Top	50
Casings—How Repaired	48	Storing Cars	50
How to Remove Tires	48	To Keep Car Clean	50
Repair Puncture	49		
Cooling System		Muffler	
Causes of Overheating	19	What It Is For	41
Purpose	19	How to Disconnect	41
Radiator Care in Winter	21		
Repairing Radiator	21	Operation	
What to Do When Overheated	19	Adjustments—What to Do	9
Engine		Cranking	5
Carbon—How Removed	16	Gasoline	3
Connecting Rod and Bearings	17	Getting Ready to Start	3
Engine Fails to Start	55	Hand Lever	8
Engine Lacks Power—Runs		Oiling	3
Irregularly	55	Slow Speed, Brake and Reverse	7
Engine Stops Suddenly	55	Spark—How Controlled	9
Engine Overheats	55	Speed—How Controlled	9
Engine Knocks	55	Starting	8
Knocking—Causes	15	Starting in Cold Weather	7
Main Bearing—How Adjusted	18		
Piston	11	Rear Axle	
Power Plant—How Removed	17	Differential Gear—How removed	39
Valves	11	Rear Axle—How to Remove	39
Gasoline System		Parts	39
Carburetor—How to Adjust	24	Universal Joint—To Disconnect	39
Carburetor—How Controlled	23		
Carburetor—Trouble	24	Running Gear	
Carburetor—How it Works	23	About Wheels	43
Ignition System		Care of Springs	44
Coils	27	Its Care	42
Commutator—Its Purpose	28	Remove Front Axle	42
Magneto	27	Steering Apparatus	44
Magneto Trouble	31		
Spark Plugs	29	Transmission	
Where to Look for Trouble	29	Bands	35
Lubricating System		Clutch	33
How it Differs from Others	45	Planetary Transmission—What	
Kind of Oil to Use	45	Is It	33
To Fill "Dope" Cups	45	Transmission—How Assembled	37

Model T Truck

The Rear Axle Assembly, How Removed	51
The Worm, How Removed	51
Lubricating the Differential	54

The F. A. Starting and Lighting System

(Installed on Sedans and Coupes)

Type of System	55
Getting Ready to Start	55
The Starting Motor—What if it Fails to Act	57
Oiling the Starter and Generator	57
The Starter—How Removed	59
The Generator—How Removed	61
The Battery — Repairing, Recharging and Guarantee	61-62